

Technical Specification



Frequency Range(GHz)	0.7 - 6.0
Gain	Linear: 8dBi Typ.
	Circular: 8dBic Typ.
Polarization	H,V, LHCP & RHCP Switchable
Axial Ratio(dB)	2.0 Typ.
	6.0 Max.
VSWR	2.5:1 Typ.
Connector	SMA-Female
Power Handling(W)	20 CW (Cold Switching)
Power Supply	12V DC
Control	TTL
Control Connector	Circular 10-Pin
Material	Al
Size(mm)	310 x 310 x 535
Net Weight(Kg)	5.85 Around

Outline Drawing (Size: mm)

SMA Female Output

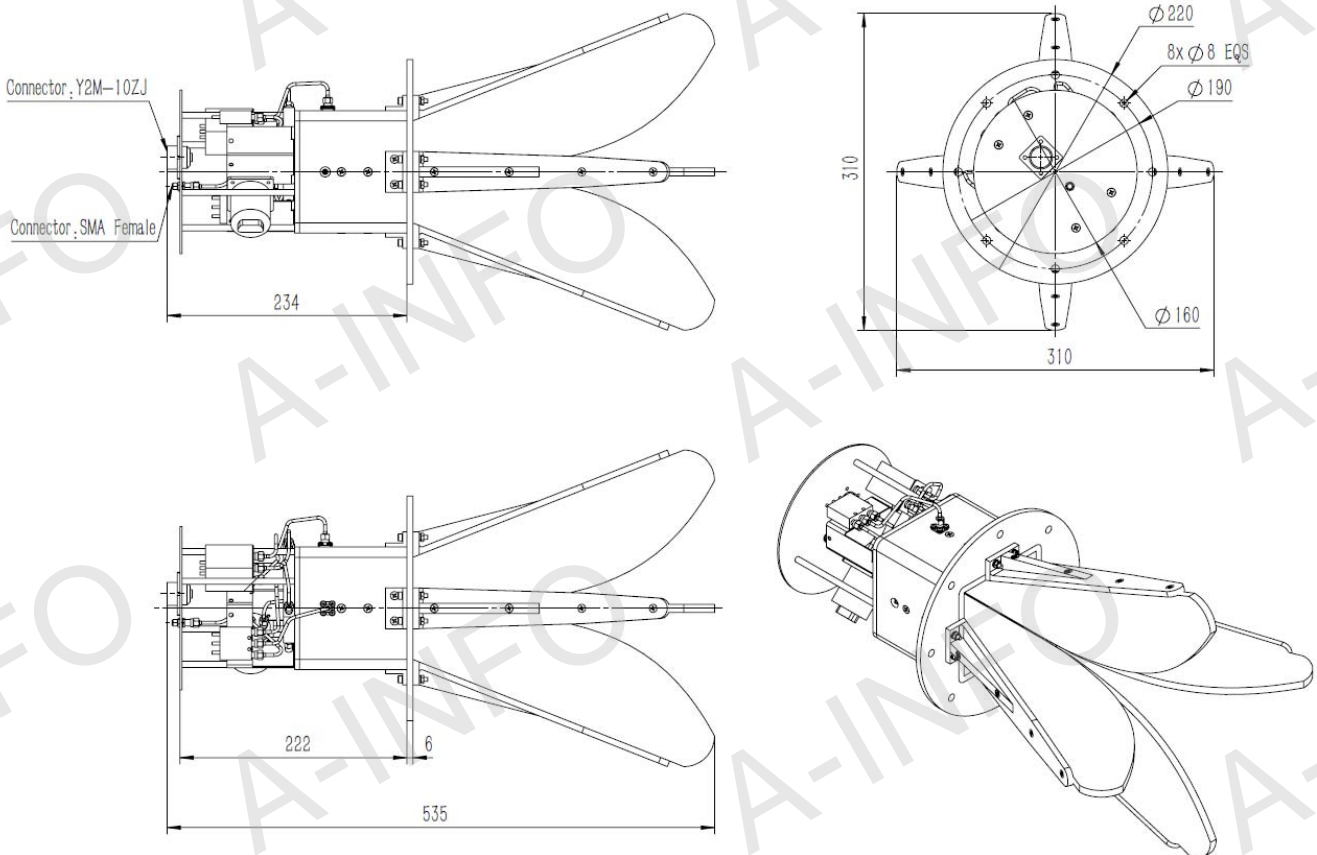

SMA Female Output with L type mounting bracket

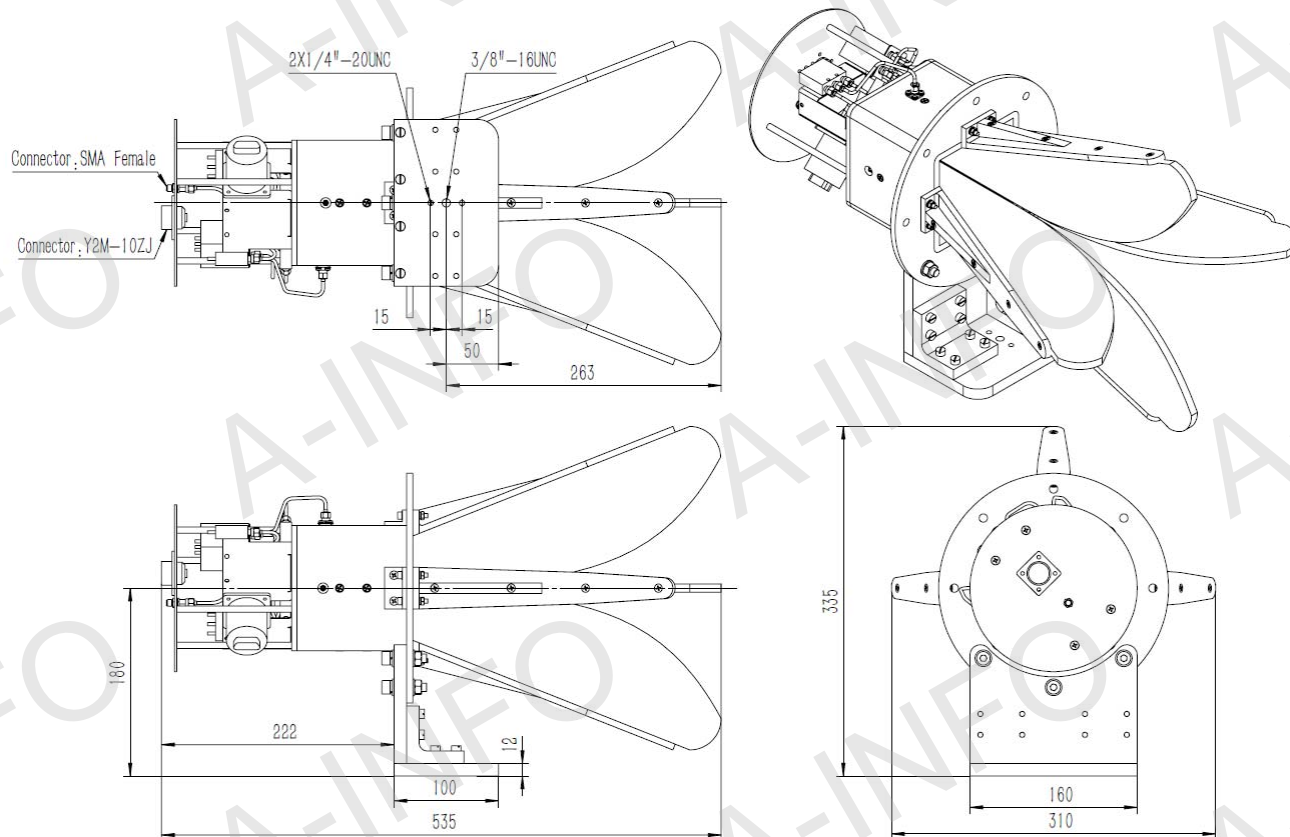

Standard Configuration

1. Antenna
2. Control Cable, 5m, with Circular 10-Pin connector on each side.

Optional Accessories

1. Nonmetallic L type mounting bracket, for A-INFO tripod
2. Aluminum Tripod, 15Kg
3. Wooden Tripod, 15Kg

Control Description

1. Pin Description

Pin Number	Name	Description
1	NC	
2	+12V	+12V DC Supply input
3	GND	Ground
4	H	Polarization control :Horizontal
5	V	Polarization control :Vertical
6	C/L	Polarization control :Circular or Linear
7	R	Polarization control :RHCP
8	L	Polarization control :LHCP
9	NC	
10	NC	

2. Function Table

Pin \ Pol.	4	5	6	7	8
V	1*	0	0	0	0
H	0	1*	0	0	0
RHCP	0	0	1*	1	0
LHCP	0	0	1*	0	1

* TTL level should be keep at “1” (high level)

Test Results

1. Gain

Linear Gain

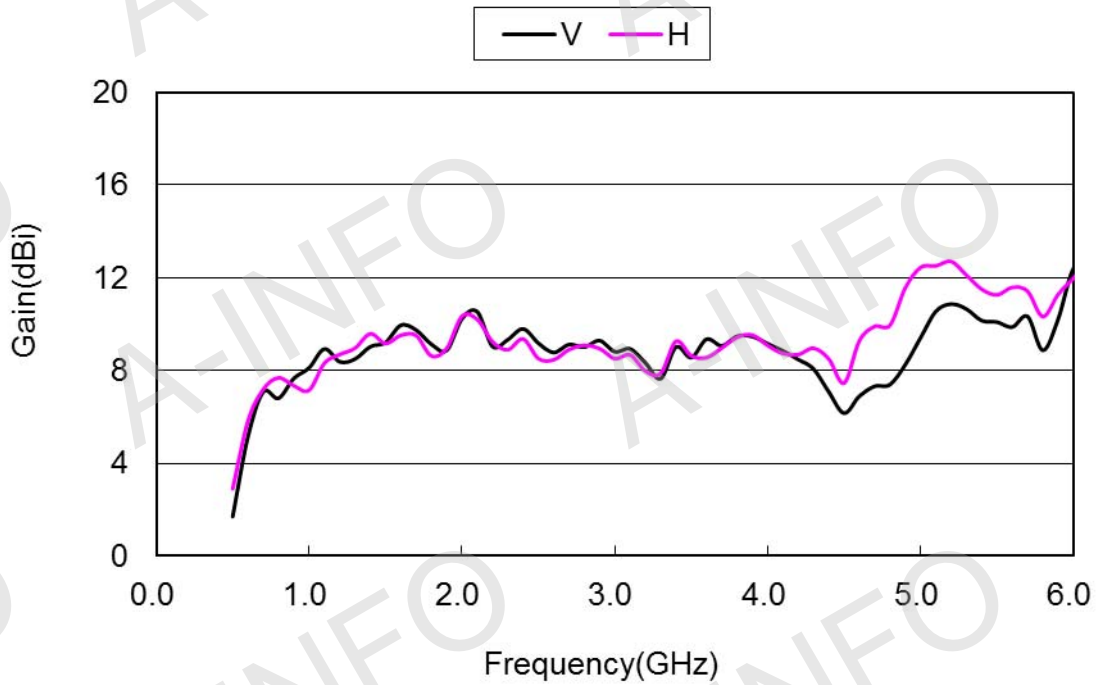

Circular Gain

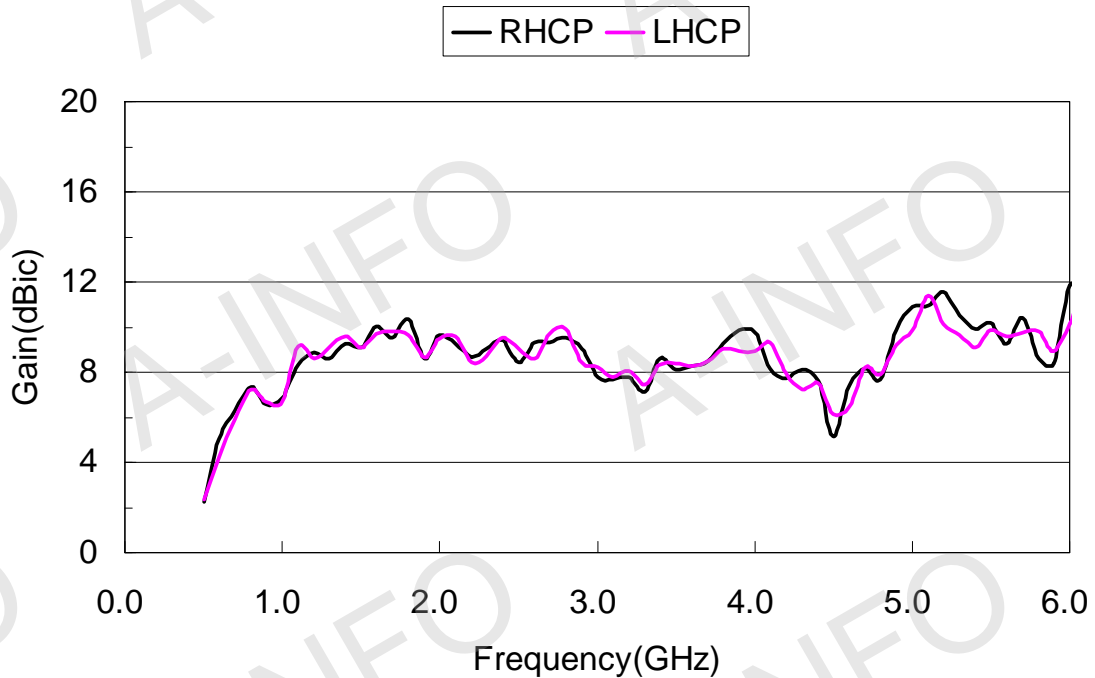

2. Axial Ratio

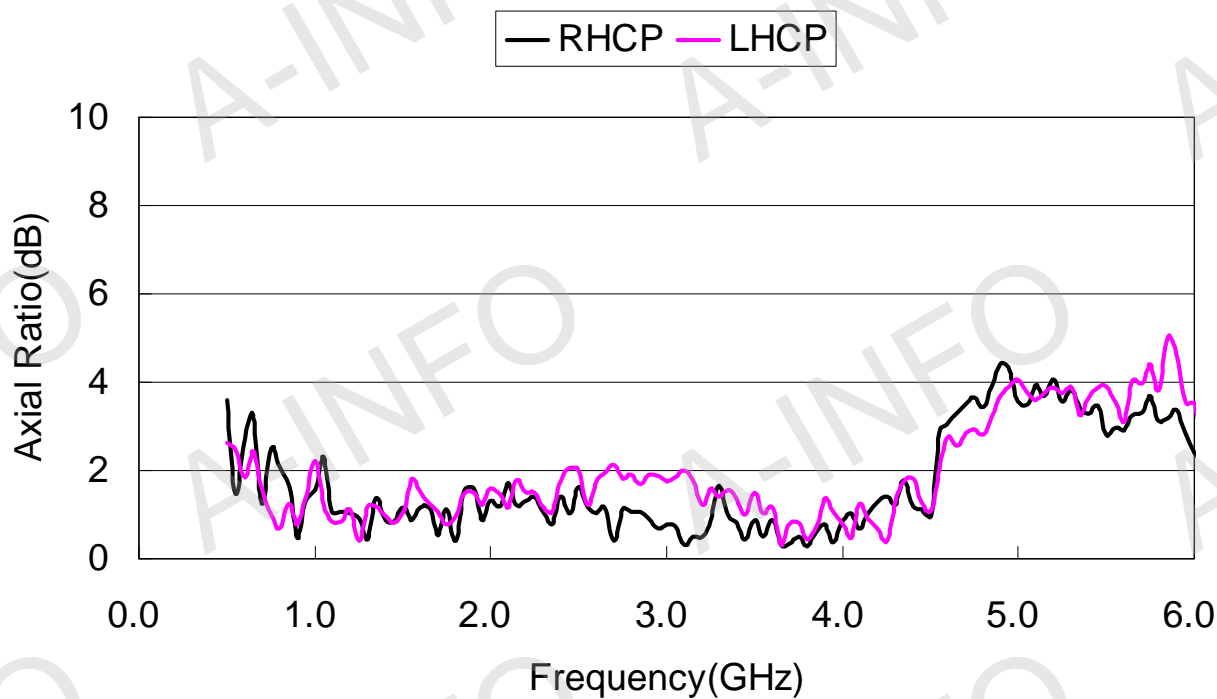

3. VSWR H Polarization

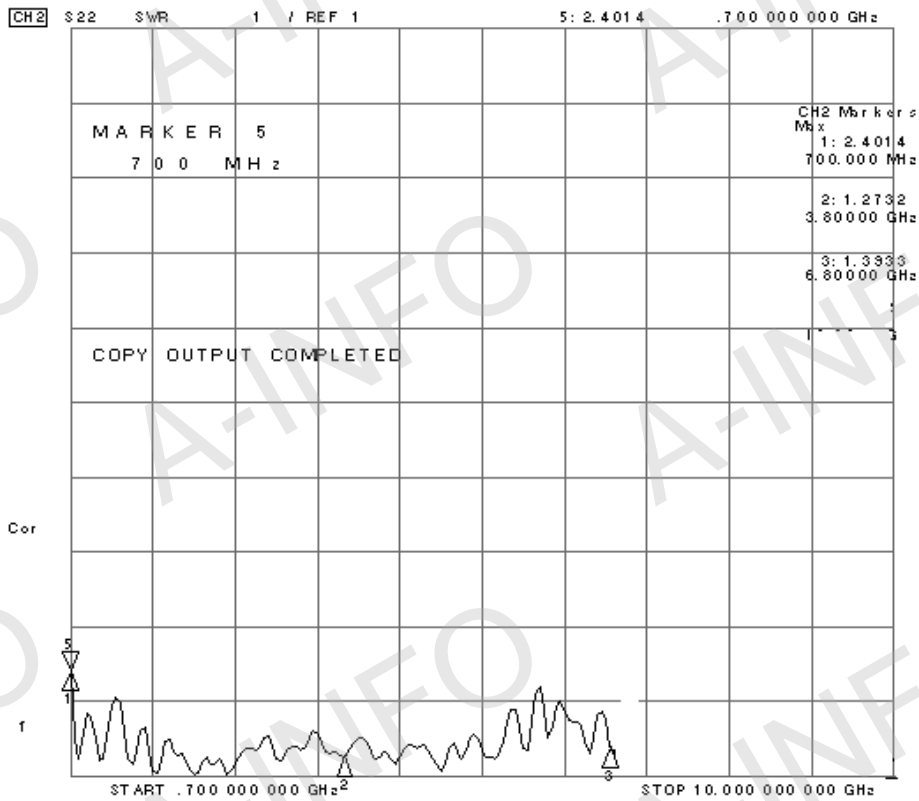

V Polarization

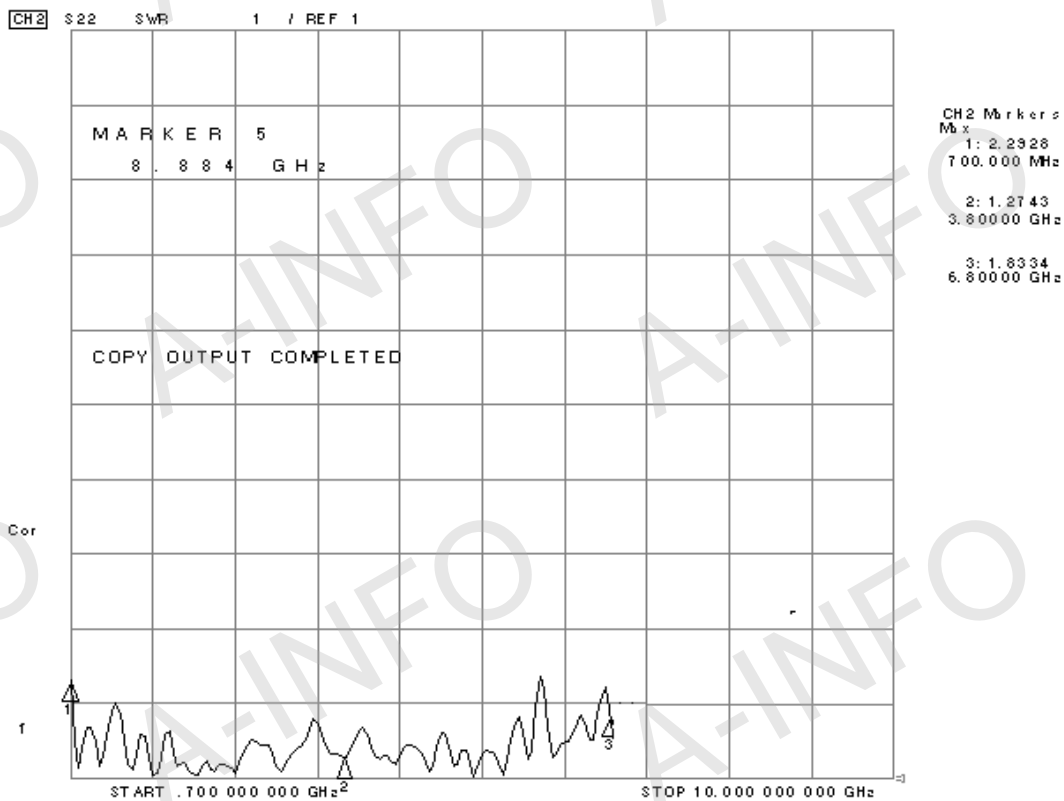

LHCP

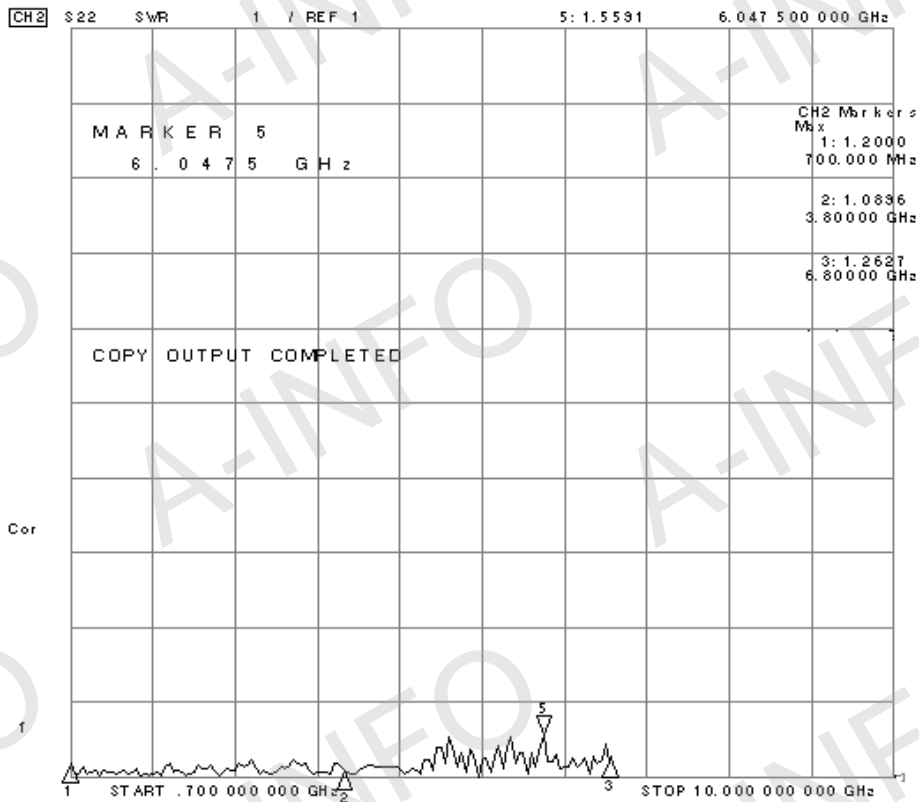

RHCP

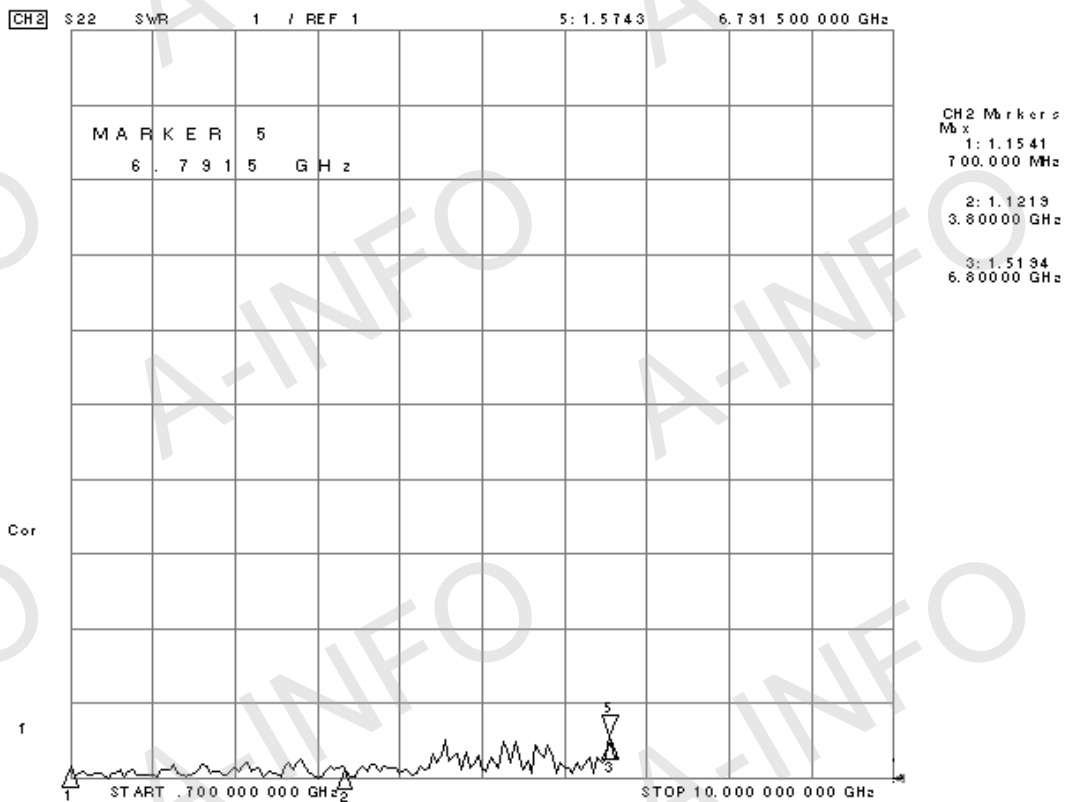

4. Pattern

Linear Polarization

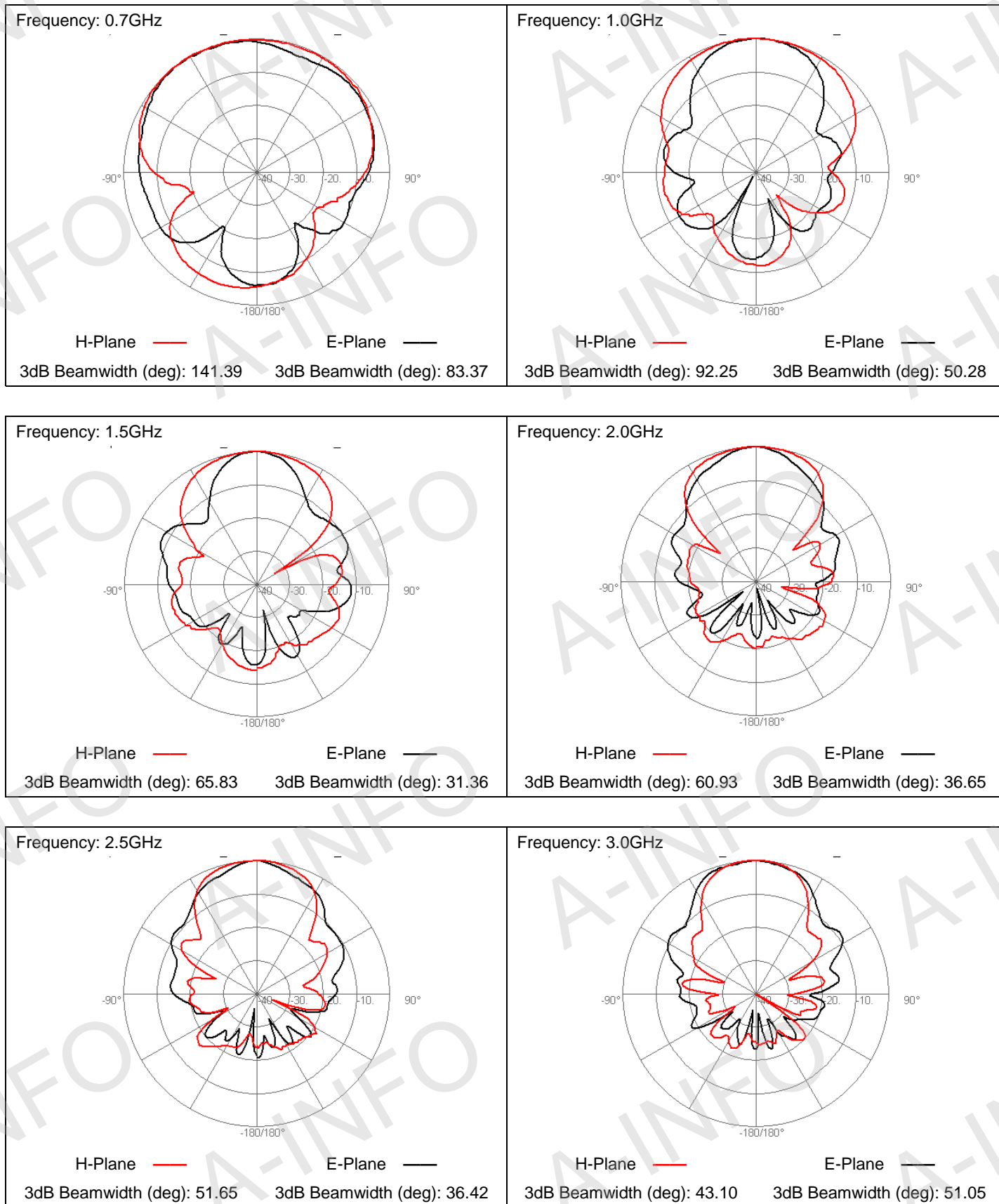

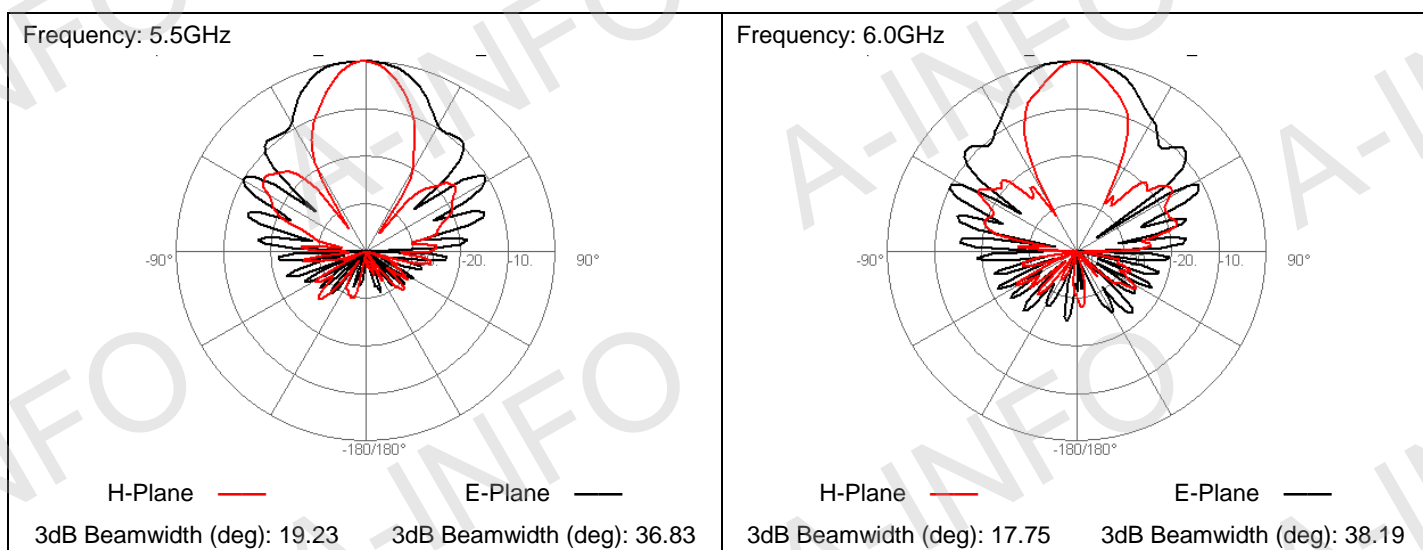
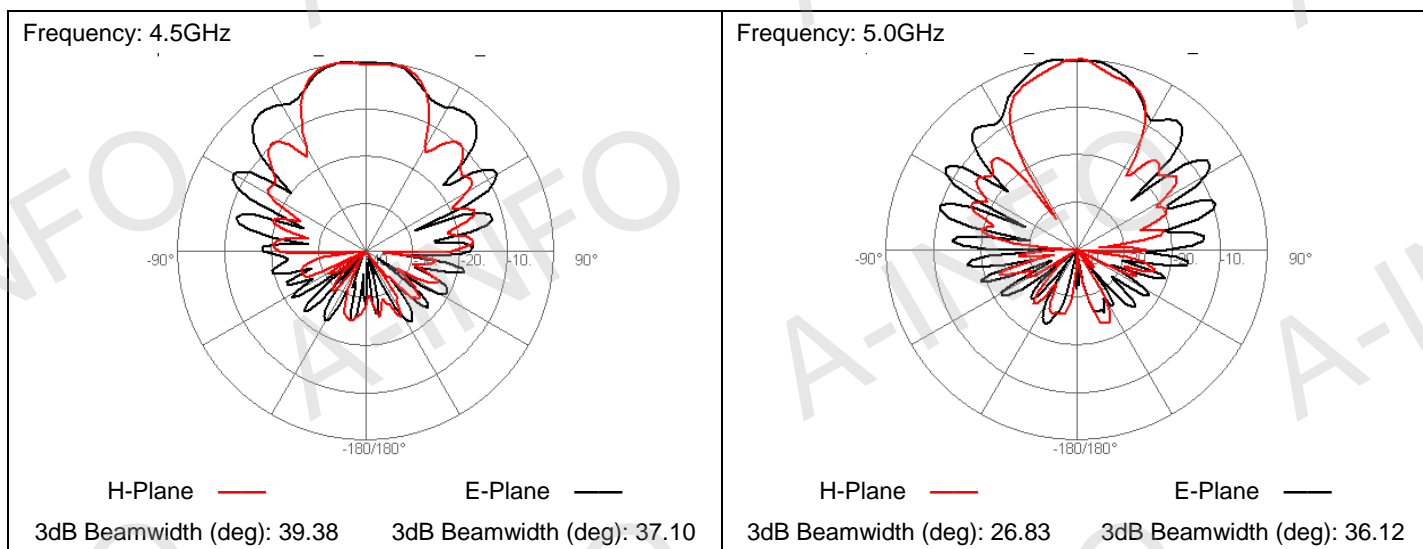
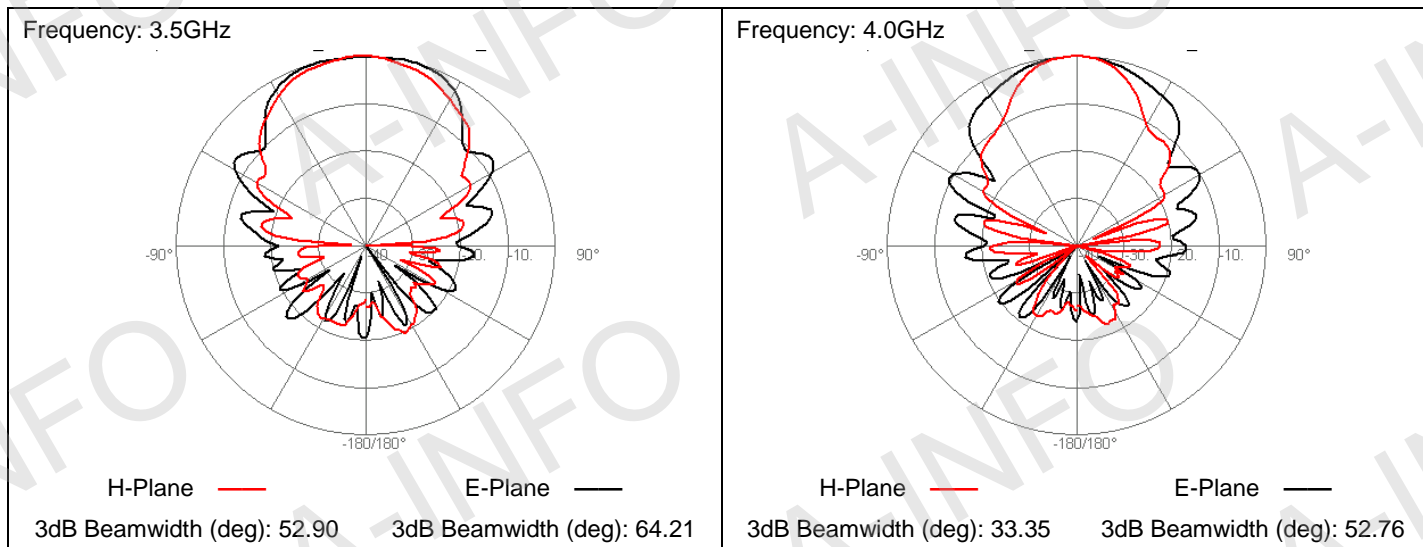

LHCP

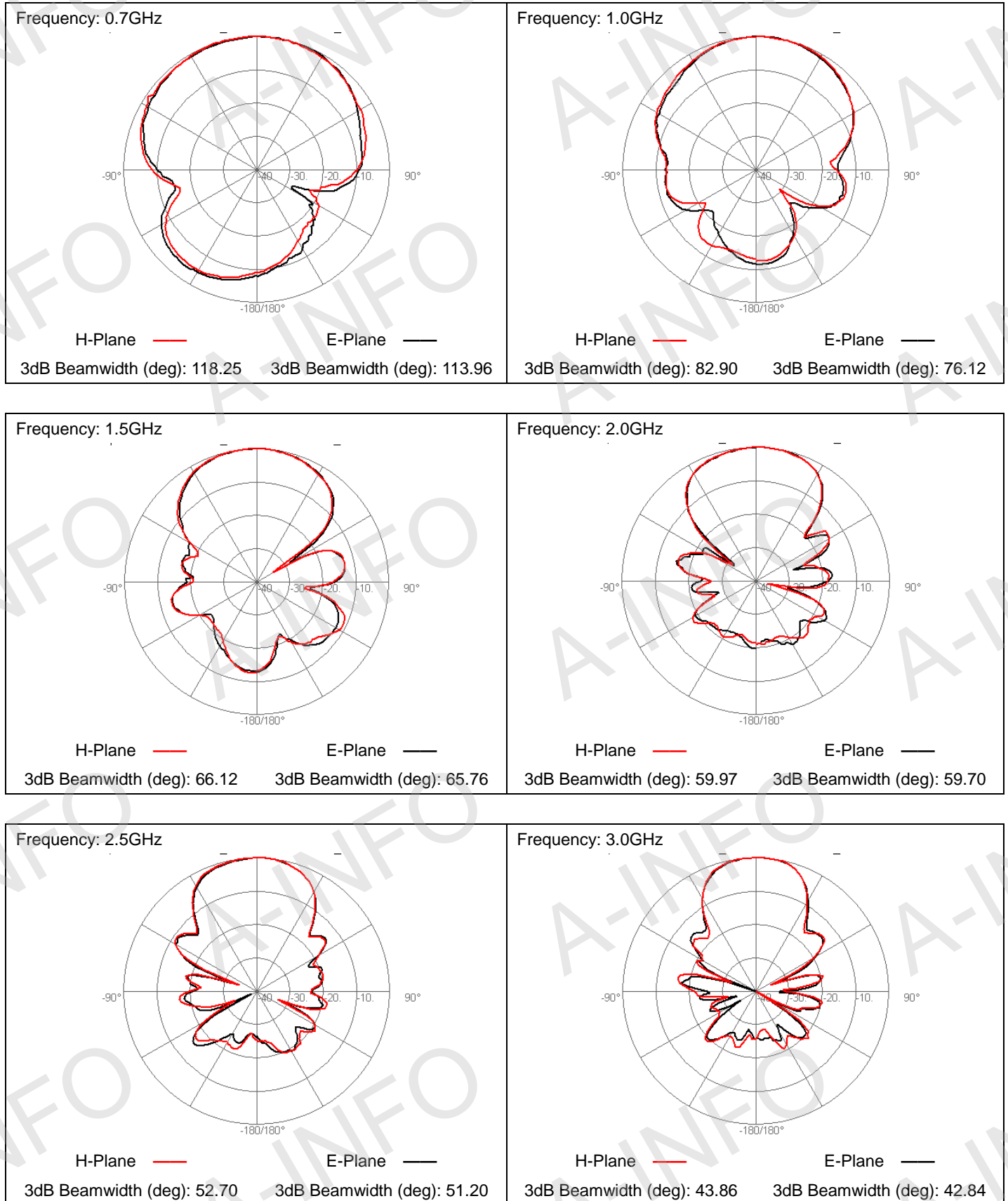

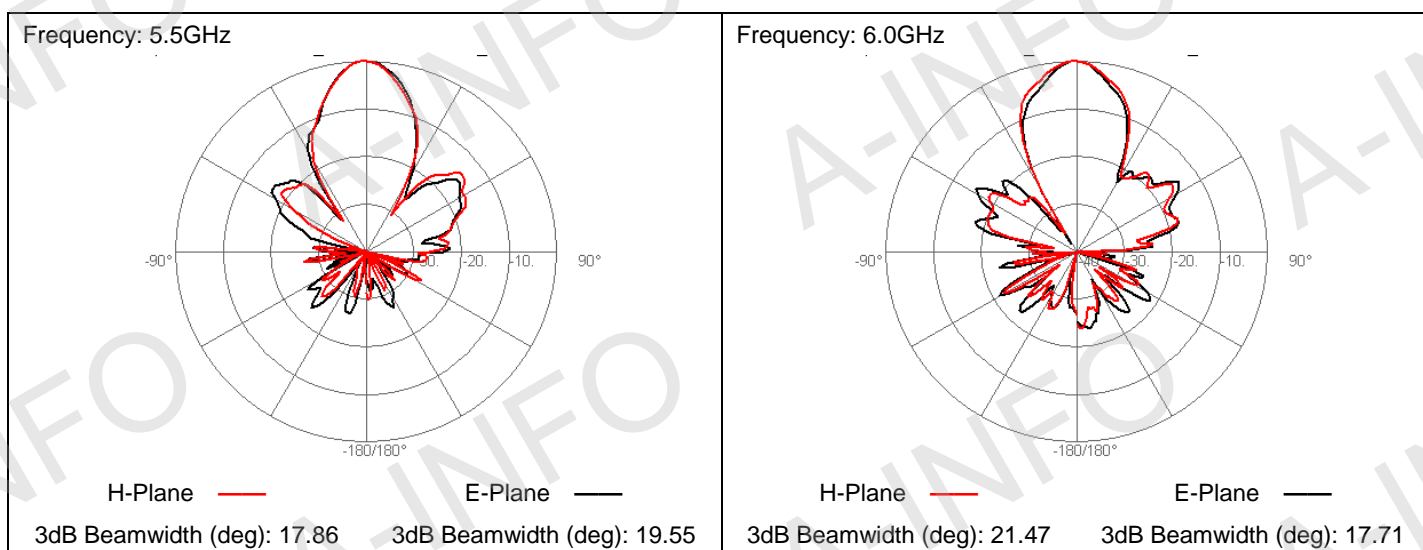
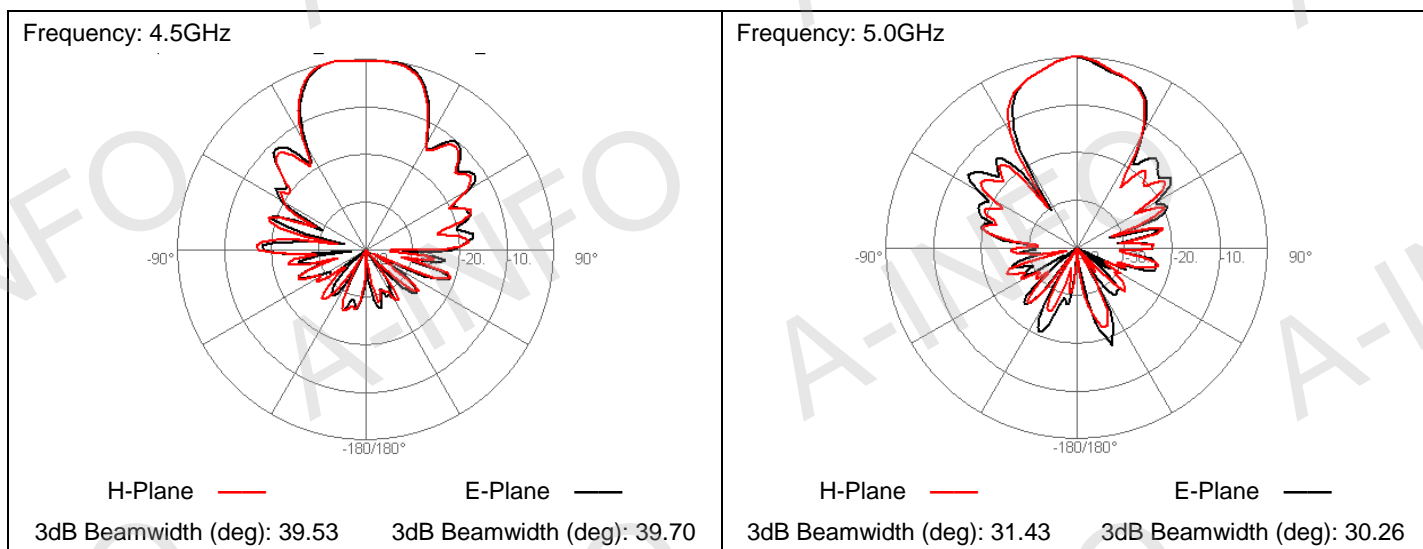
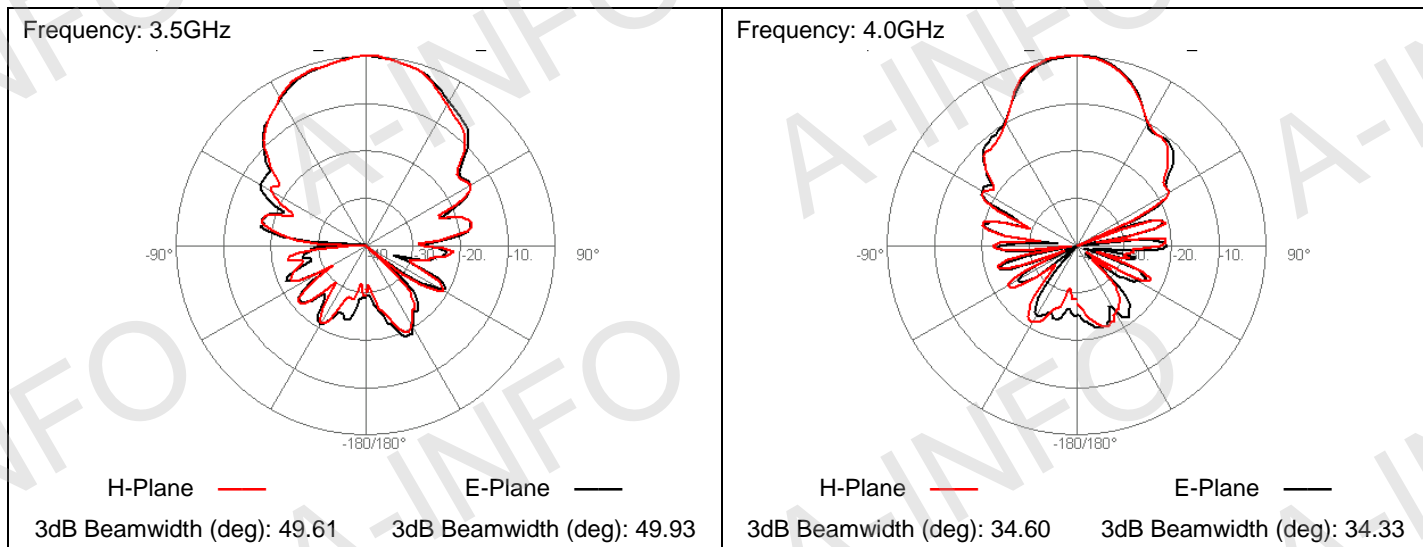

RHCP

