

Technical Specification



Frequency Range(GHz)	2.2 - 3.3
Waveguide	WR340
Gain(dBi)	5 Typ.
Polarization	Linear
3dB Beamwidth(deg)	E Plane: 98 Typ.
	H Plane: 63 Typ.
Cross Pol. Isolation(dB)	30 Typ.
VSWR	2.0:1 Typ.
Output	Endlaunch N-Female or Endlaunch SMA-Female
Material	Al
Size(mm)	138.1 x 95.3 x 597.2
Net Weight(Kg)	1.35 Around

Outline Drawing (Size: mm)

340EWGEN (With Endlaunch N-Female Output)

For Endlaunch SMA-Female output outline drawing, please contact A-INFO.

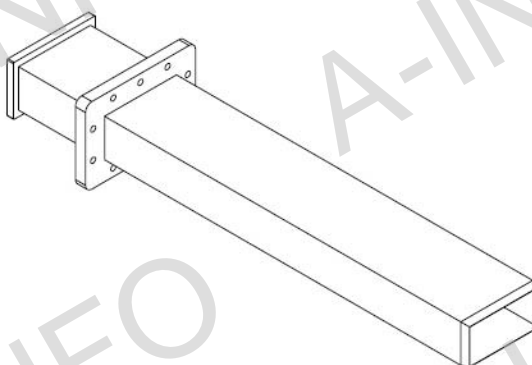
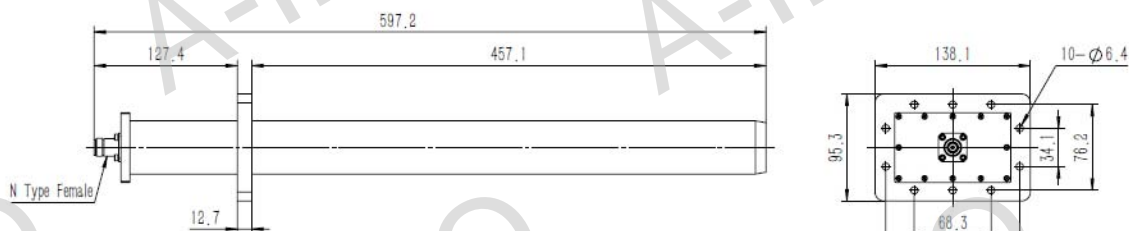

Test Results

VSWR

