

SCHWARZBECK MESS - ELEKTRONIK

An der Klinge 29 D-69250 Schönau Tel.: (+49)6228/1001

Fax.: (+49)6228/1003 E-mail: office@schwarzbeck.de

DESCRIPTION, DATA SHEET

9 kHz - 30 MHz

Interference Measuring Receiver

FCKL 1528

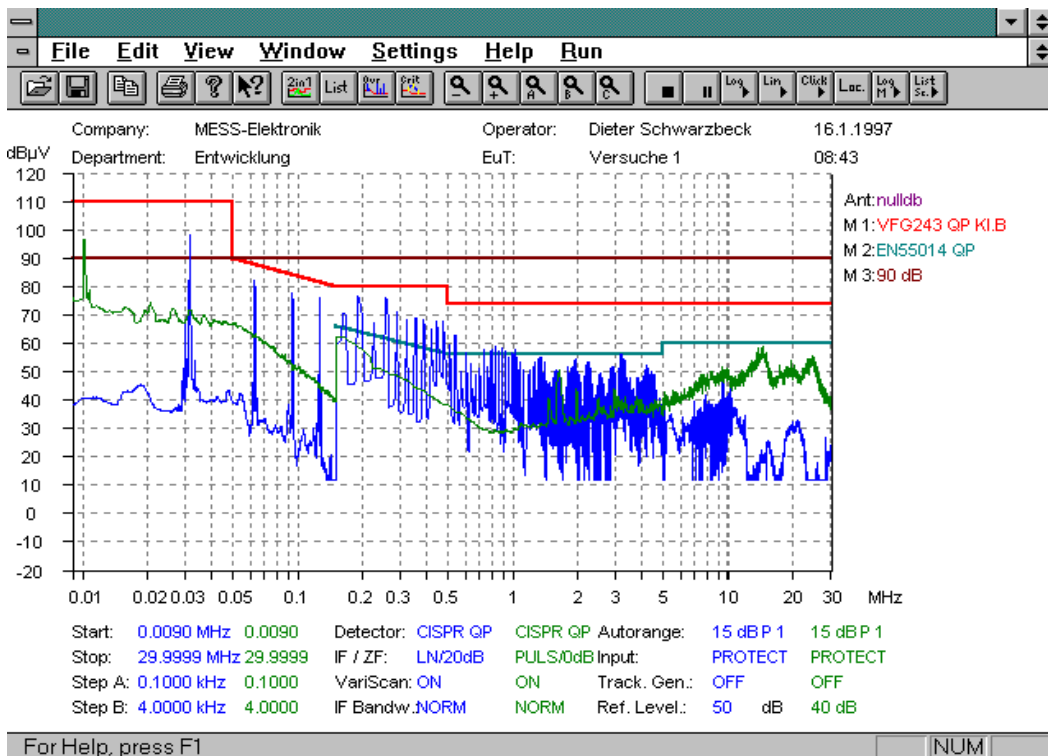
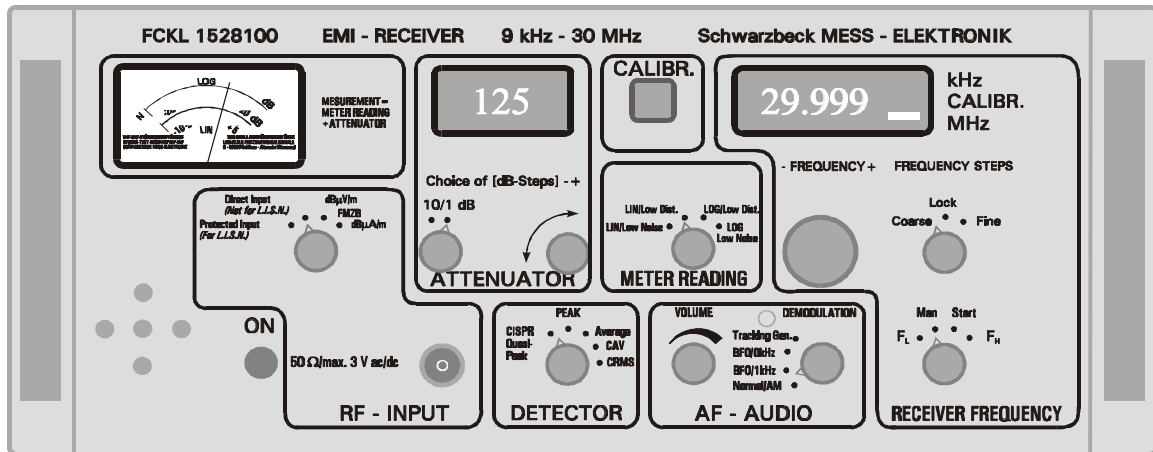

- ◆ Frequency range 9 kHz - 30 MHz
- ◆ 10 Hz - Frequency steps
- ◆ Conducted interference measurement with L.I.S.N.
- ◆ Field strength measurement with adapter.
- ◆ Integrated power attenuator for receiver protection.
- ◆ Optional high level tracking generator is ideal to measure **Lamp attenuation acc. to EN 55015**.
Also for filter attenuation, free area attenuation and to drive power amplifiers.
- ◆ Manual Operation, semi-automatic operation with xy-recorder and PC-control via IEEE-bus using the Schwarzbeck software.
- ◆ Fast 100% CISPR Quasipeak, CAV and CRMS measurement with VARISCAN.

For many decades, most of the interference measuring receivers were used in laboratories. They were operated manually using their front panel. This type of operation including front panel control will still be there in the future, but PC-control gives value added measurement because of increased speed and better documentation. The unique r. f. and analogue circuits of the FCKL 1528 give precise measurement with or without PC-control. The receiver comes complete for EMI-measurement, but can be equipped with useful options.

Characteristics of the FCKL 1528

Unique R.F. - circuitry

- ◆ Attenuator with r.f.-relays uses resistive Π -attenuators with 1 dB steps. Total resistive attenuation is 95 dB.
- ◆ Switchable 10 dB high-power-attenuator with 10 W for safe measurement with L.I.S.N.s up to 4 x 400 A.
- ◆ 5 Input filters. Shape factors optimised for EMI - measurement.
- ◆ CISPR standard filters with 200 Hz and 9 kHz / - 6 dB. Filters are classic double tuned band filters.
- ◆ Integrated 25 Hz / 100 Hz Pulse-standard for CISPR Band A and B

similar to IGLK 2914 for calibration. Error is compensated by a EPROM list.

- ◆ Integrated (optional) tracking generator with 120 dB μ V (1 V) / 50 Ω for measurement of **Lamp attenuation**, filter attenuation, field attenuation with antennas and amplifier drive.

High precision measurement

- ◆ Meter with 2 large scales.
Linear voltage scale with 1 dB-scaling for the amplitude range
-10 dB / 0 dB centre of meter +6 dB
according to EN 55014 C.2.1.
plus Logarithmic overview
-25 dB / 0 dB centre of meter +25 dB

- ◆ 12 Bit A/D-converter

Easy to use

- ◆ Functional areas of controls and displays.
- ◆ Small size, moderate weight
- ◆ Rugged Aluminium cabinet
- ◆ Low heat dissipation
- ◆ Due to effective shielding no problems even when used in the shielding room.

Data Interface

IEC-Bus-Interface: Connector 24 sockets

Sub D-Connector 25 sockets

Supply Voltages d.c. +12 V / -12 V for auxiliary equipment

XY-recorder control Frequency Amplitude, Penlift

Output voltage of active Demodulator (Envelope) for auxiliary or monitoring with Oscilloscope

Sub-D-connector 9 sockets for L.I.S.N-control

BNC-Outputs

I. F.-Output

Tracking generator output 120 dB μ V 50 Ω (optional)

Modes of operation

The FCKL 1528 covers the following modes:

Manual operation with manual frequency tuning and reading the measurement from the meter.

Semi-automatic operation using an xy-recorder for the reading.

PC-controlled operation via IEEE-bus with Schwarzbeck Software.

Manual operation

As no other this mode of operation gives direct access to the receiver without any collision with PC or software. Especially in the measuring field outside of a shielding room, broadcast signals can be identified using the demodulator/loudspeaker. CW-signals can be monitored with 0 kHz and 1 kHz beat frequency.

Reading can be seen clearly on the meter which gives perfect reading from narrow band signals down to single click.

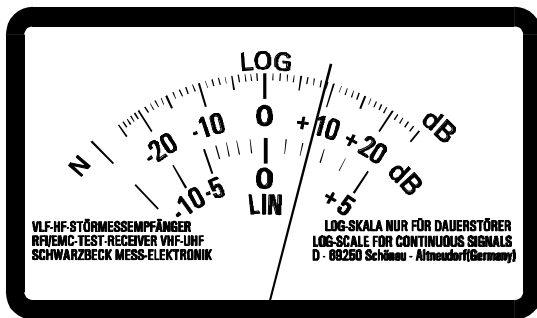

The meter uses the classic 0 dB centre of meter scaling for safe measurement without interpretation.

The linear scale gives true linear voltage reading avoiding problems with slow pulses.

For any interference signal from continuous distortion to single click 0 dB centre of instrument is free of overload problems. For overview a 50 dB scaling can be used.

Semi-automatic operation

Spectrums can be recorded when the receiver is used in the scan mode together with an xy-recorder.

The time consumption is reduced substantially, because VARISCAN adjusts scan speed to the signals ahead.

So spectrum can be scanned directly in CISPR-Quasipeak to avoid switching CISPR/Peak. The xy-recorder can be used in manual tuning mode as well. The xy-recorder then follows the manual frequency tuning on the encoder. Doing so, it is very easy to stop on critical frequencies to find the maximum signal strength, which will be kept by the xy-recorder.

PC-controlled mode

Using a standard PC, a IEEE-card and the Schwarzbeck software Messbase together with the FCKL 1528 gives PC-controlled measurement. Modern PCs offer high speed and high capacity hard disks which improve considerably storage and documentation of measurement.

Primary goal of development was safe measurement of the complete range of interference signals keeping the high standard of manual measurement. This means that there must be no trade off considering even slow pulses.

The completely new approach using the fourth demodulator included in VARISCAN gives fast Quasipeak, CAV and CRMS measurement without using the Peak detector. VARISCAN analyses the signal ahead before it is really measured.

Practical spectrum often shows amplitude jitter which could be subject to misinterpretations using the Peak detector to decide which signal has to be re-measured in Quasi-Peak or not.

The second step towards safe measurement is controlling the receiver by the limits given in the standards.

Basically autorange can catch any signal, but there are restrictions when slow pulses occur.

The way out of the problem is to guide the receiver along the limits in such a way, that it is centred in the middle between noise and overload. Even antenna factors are included in this strategy.

SCHWARZBECK MESS - ELEKTRONIK

An der Klinge 29 D-69250 Schönau Tel.: 06228/1001 Fax.: (+49)6228/1003

Messbase-Software for Emission-tests under MS-WINDOWS 95/98/NT/2000/XP

- Easy to learn and to use
- Fast & Reliable with Variscan and Autorange
- High security against overload using mask-guidance
- User editable limits and antenna factors guarantee high flexibility
- Interactive final measurements with automatic test report generation
- Automatic creation and scan of frequency lists
- Free scalable prints
- User definable creation of test reports
- Convenient graphic features and data transfer to other Windows applications
- Marker with integrated final measurement capability
- Subranges reduce measuring time and provide data reduction
- Remote control for LISN or coaxial switching unit included
- Additional IEEE 488-devices can be integrated on request
- Attenuation measurements > 100 dB for site performance checks or insertion loss of filters
- Comparison of two measured diagrams and up to 3 masks simultaneously
- Accelerator keys for frequently used functions speed up operation
- Click measurement with 10 samples per second
- Context sensitive Online Help
- Macros performing up to 32 time-consuming measurements
- Find the Maximum Envelope out of a set of measurements

Hardware - Requirements:

IBM-compatible PC with 80386 and math. Coprocessor 80387 or better, 4 MByte RAM, VGA-Graphics, min. 10 MByte free space on hard disk, 3.5" floppy disk drive, INES IEEE 488 16-bit interface card. PCMCIA-card also available for portable Computers.

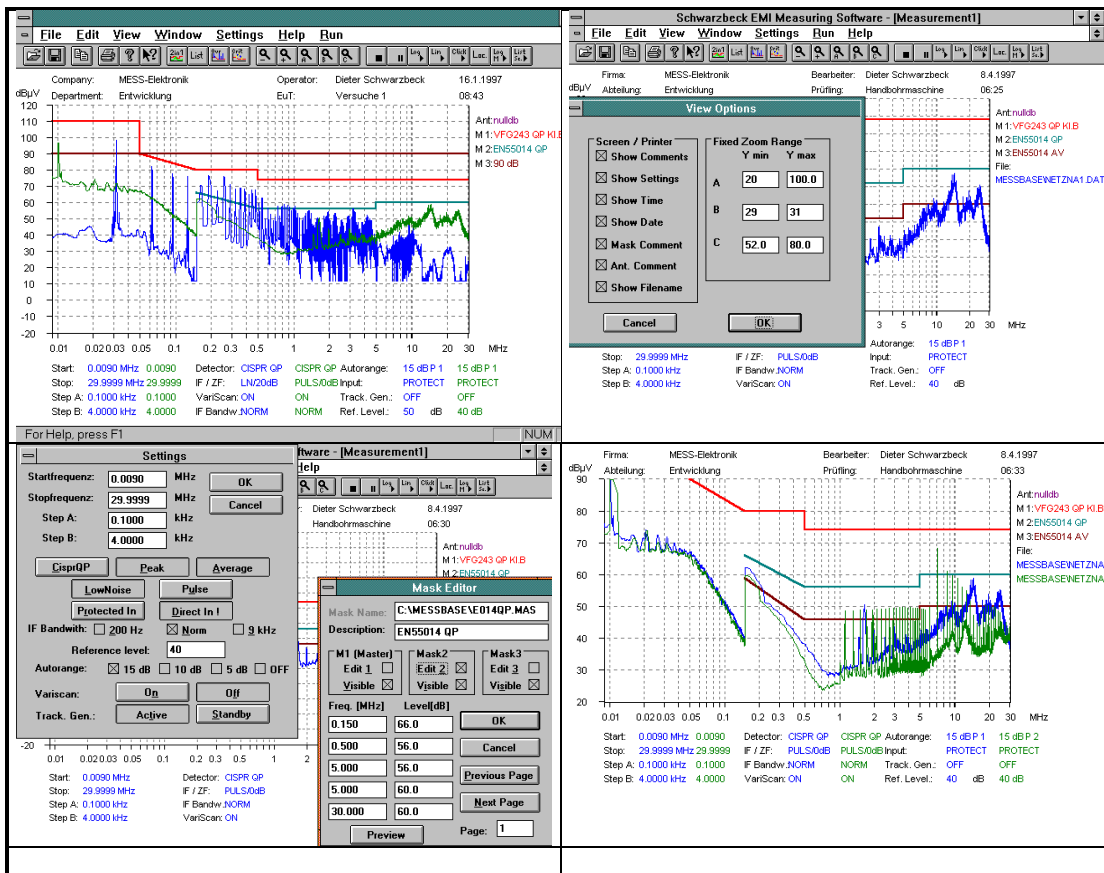

FCKL 1528 Technical data

Detectors	Peak Average CISPR Quasi-Peak CISPR-Average CISPR-RMS	PK AV QP CAV CRMS
Frequency range	9 kHz-30 MHz	
Frequency tuning	with encoder wheel 10 Hz-10 kHz,	
Display	6 digits LED	
Software	Start- and Stop frequency random, > 10 Hz, automatic scanning with graphic.	
Frequency error	$1 \cdot 10^{-5} \pm 100$ Hz	
R.F.-Input	BNC-connector, 50 Ω	
SWR	<1,2 for attenuator >10 dB <2 for attenuator 0 dB	
Oscillator voltage on R.F. Input	<30 dBpW for attenuator 0 dB <20 dBpW for 10 dB power attenuator	
R.F.-Prefiltering	5 Bandpass filters switched by relays	
	1 9 kHz - 150 kHz	
	2 150 kHz - 3 MHz	
	3 3 MHz - 10 MHz	
	4 10 MHz - 20 MHz	
	5 20 MHz - 30 MHz	
Calibration		
Pulse standard for CISPR 3	Standard 25 Hz, nom. 30 dB μ V (25 Hz)	
Pulse standard for CISPR 1	Standard 100 Hz, nom. 30 dB μ V (100 Hz)	
Maximum Input Level		
R.F.-attenuation 0 dB (no D. C.-isolation)	D.C. 7 V Sine wave R.F. voltage 130 dB μ V (3,16 V)	
R.F.-attenuation 10 dB (D. C.-isolation)	Spectrum pulse density 96 dB μ V/MHz	
R.F.-attenuation 10 dB power attenuator	D.C.-voltage 15 V Sine wave R.F. voltage continuous 141 dB μ V (3 W) Intermittent 20% on, Burst<0,5 sec. 143 dB μ V (5 W)	
Spurious, Large Signal Handling Capability		
Image frequency atten.	>65 dB / typ. 90 dB	
I.F.-isolation	>70 dB / typ. 90 dB	
Spurious	None	

Third order Intercept d3
standard setup >25 dBm
(>15 dBm w.o. power attenuator.)

R.F.-feed through
(1 dB error, w.o. receiver frequ.) 10 V/m

I.F. frequencies

range 9 kHz - 150 kHz	1. I.F.	455 kHz
	2. I.F.	45 kHz
range 150 kHz - 30 MHz	1. I.F.	40 MHz
	2. I.F.	455 kHz
	3. I.F.	45 kHz

I.F.-Standard filter bandwidths acc. to CISPR3/1
200 Hz / 9 kHz (-6 dB)

Noise indication (bandwidth 200 Hz)

Average	< -30 dB μ V
Peak	typ. -18 dB μ V
CISPR Quasipeak	< -30 dB μ V

Noise indication (bandwidth 9 kHz)

Average	< -14 dB μ V
Peak	typ. -8 dB μ V
CISPR Quasipeak	< -14 dB μ V

Range for voltage measurement
(bandwidth 200 Hz)
Lower limit for <1 dB noise error

Average	< -25 dB μ V
Peak	typ. -5 dB μ V
CISPR Quasipeak	
Standard pulse 25 Hz	< -25 dB μ V

Range for voltage measurement
(bandwidth 9 kHz)

Average	-7 dB μ V
Peak	+8 dB μ V
CISPR Quasipeak	
Standard pulse 100 Hz	< -7 dB μ V

Level Indication

Digital	3 digit LED display for reference level
---------	--

Analogue Meter with 0 dB centre of instrument.
Voltage linear scale with dB scaling w.o.
logarithmic converter.
Logarithmic scale with -25 dB / 0 dB / +25 dB
(low noise).

Recording with XY-recorder Y-axis within dynamic range of demodulator linear or logarithmic acc. to meter scale.

X-axis via EPROM list and D/A-converter derived from receiver frequency.

Prefabricated measurement diagrams ready to use.

Error analogue, digital

< 1 dB (0 dB centre of meter, limit)

Demodulation AM, A0 (CW, BFO)

Beat frequencies 0 kHz and 1 kHz.

Both zero beat frequency measurement and 1 kHz

CW identification is possible even with 200 Hz - I.F.-Filter.

Inputs, outputs

Analogue

Recorder outputs Y-axis, amplitude
0 dB centre of meter corresponds to 0,5V linear, logarithmic, $R_i < 10 \text{ k}\Omega$
X-axis, frequency,
9 kHz at 0 V,
30 MHz at 1,000 V
Pen Down $R_i < 2 \text{ k}\Omega$

Measuring outputs

Active demodulator (Envelope of I.F.)
0 dB centre of meter corresponds to 150 mV, $R_i > 10 \text{ k}\Omega$
Pulse weighted output see Y-axis xy-recorder

I.F.-output optional

Supply voltages for auxiliaries +12 V / 100 mA
-12 V / 50 mA

Control and supply

L.I.S.N. 4 Bit code
Connector 9-pin socket
Path select, +12 V supply

Conn. 24-pin socket IEEE-Bus-Controller

Options

Tracking generator (optional, build in)

Frequency range 9 kHz-30 MHz

Frequency steps same as receiver

Output voltage 120 dB μ V (1 V) / 50 Ω

Control Rotary switch on front panel,
Software

Option 19" build in capability

General

Nominal temperature range 0°C to 50°C

Storage temperature range -20°C to +70°C

Cooling Temperature controlled,
low noise cooling fan.

EMI acc. VDE 0876, 1a

Shock, Vibration acc. to DIN IEC 68-2-27/29

Power supply 110,130,220,240 V +-10%
50 , 60 Hz 80 W
12 V DC optional

Cabinet

470 mm x 180 mm x 460 mm
approx. 17 kg

Standard accessories

Mains cable, Operation manual

Recommended accessories

A) Measuring conducted voltage with manual or software control.

L.I.S.N. 2 x 10 A NSLK 8127
L.I.S.N. 4 x 16 / 25 ANSLK 8126
L.I.S.N. 4 x 32 / 50 ANSLK 8128
L.I.S.N. 4 x 100 ANNLK 8121
L.I.S.N. 4 x 200 ANNLK 8129
L.I.S.N. 4 x 25 A
150 Ω / (V) NNBM 8112
L.I.S.N. 2 x 10 A
150 Ω / (V) NNBM 8114
L.I.S.N. 2 x 10 A
150 Ω / Delta (symm./asymm.) NNBM 8116
Automotive L.I.S.N.
5 μH // 50 Ω, 70 A, 1 Path NNBM 8125
Automotive
5 μH // 50 Ω, 100 A, 1 Path NNBM 8126 A
300 MHz, 10 (20) A NNBM 8126 B
VHF - L.I.S.N.
4 x 25 A, DC/AC 50/60/400 Hz UNN 8122

T - L.I.S.N. (Telecommunication)

T-L.I.S.N.
HF, 10 kHz-30 MHz NTFM 8132
T-L.I.S.N.
VHF, 300 MHz NTFM 8133
T-L.I.S.N.
Extremely symmetric NTFM 8135
T-L.I.S.N.
Four wire, 9 kHz-30 MHz
150 Ω NTFM 8138

B) Probes for conducted voltage

R.F.-Probe, 150 Ω TK 9415
R.F.-Probe, 1,5 kΩ TK 9416
R.F.-Probe 2,5 kΩ TK 9417
High voltage probe TK 9420

C) Adapters for field strength

Adapter for magnetic field strength 9 kHz-30 MHz with constant conversion factor FMZB 1516
Adapter with small loop, up to 20 V/m fictive E-Field-strength FMZB 1517
same as FMZB 1517, but up to 150 V/m fictive E-Field-strength FMZB 1527

D) Others

Transformers, converters

Symmetric/Unsymmetric transformer
105 Ω SYM 9223
Current converter
10 kHz-200 MHz SW 9602

Modulator HM 7001 9 kHz-30 MHz for modulated R.F. acc. to IEC 801

Near field probes FS-SET 7100, magnetic, elektric, separator, power supply, Box.

FCVU 1534 is the corresponding EMI receiver for the frequency range 20 MHz - 1050 MHz. It is especially designed for EMI-requirements in this frequency range. A build in power attenuator protects the receiver under all circumstances.

The optional external preamplifier uses a standard coaxial cable for remote power supply and remote control. Connecting the preamplifier directly at the antenna eliminates cable loss.

The optional tracking generator delivers 1 V / 50 Ω . It can be used for filter measurement with extremely high dynamic range or for testing attenuation between 2 antennas in free area or anechoic chamber.

The receivers are similar in manual and PC controlled operation.

A multitude of antennas, clamps and other accessories makes this receiver a versatile tool for EMI - measurement.

This is only a part of our EMI-program. Please ask for more information.

Equipment may be subject to modification without any notice. Specifications without tolerance should be considered as order of magnitude.

SCHWARZBECK MESS - ELEKTRONIK

An der Klinge 29 D-69250 Schönau Tel.: (+49)6228/1001
Fax.: (+49)6228/1003 E-mail: schwarzbeck@t-online.de

Manual

Operating Instructions

INTERFERENCE MEASURING RECEIVER

9 kHz - 30 MHz

FCKL 1528

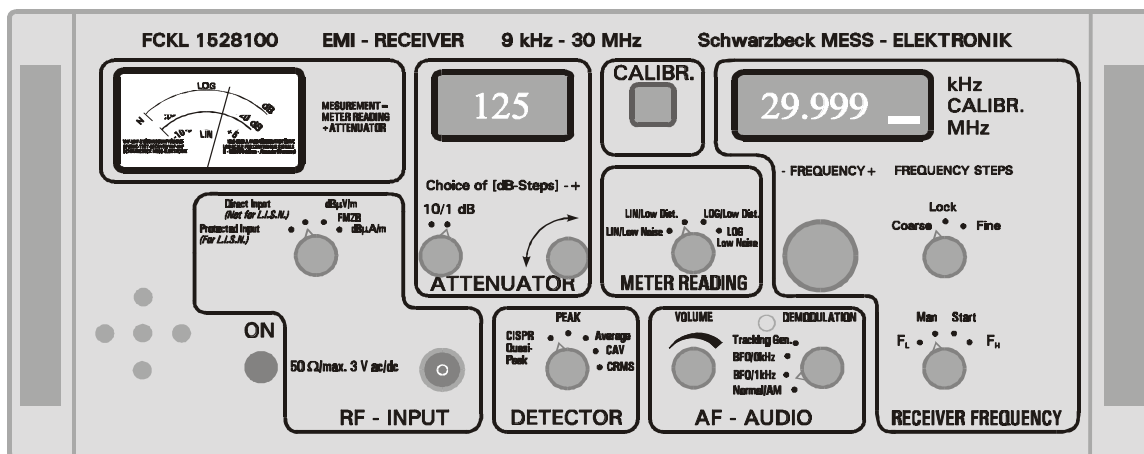

Interference measuring receiver for front panel operation with or without
xy-recorder

and for

PC-controlled operation via IEEE-bus with the SCHWARZBECK
Messbase software.

FCKL 1528 Manual, Operation Instructions

Table of contents

Sections	Title	Page
1	Introduction, Description	1
2	Safety-Information, Warning, Mains Voltage Selector/Fuse	2
3	Controls (Front panel)	3,4
4	Displays and controls, description	5
4.1	Reading of interference voltage	5
4.2	Attenuator area	5
4.2.1	Attenuator display	5
4.2.2	10 dB - steps	5
4.2.3	1 dB - steps	6
4.3	Calibration (key)	6
4.4	Measurement / lin/log Y / Low noise / Low distortion	7
4.5	Frequency - area	7
4.5.1	Frequency display	7
4.5.2	Frequency rotary encoder	8
4.5.3	Frequency steps	8
4.5.4	Manual / automatic tuning	8
4.6	AF / Audio area	9
4.7	Detector area	9
4.7.1	Quasi-Peak Detector QP	9
4.7.2	Peak Detector PK	9
4.7.3	Average Detector AV	10
4.7.4	CISPR-Average CAV	10
4.7.4	CISPR-RMS CRMS	10
5	First steps	11
<hr/>		
Appendix Pages 12-28		
6	Front panel operation, automatic scanning	12
7	Automatic scanning, recording with xy - recorder	13
8	Rear side (description, comments, warnings)	14
9	How to connect and adjust the xy - recorder	15
10	Measuring site for interference voltage	16
11	Tracking generator	17, 18
12	Meter (Indication Instrument) and meter reading	19-23
13	Basic Function	24, 25
14	Prefabricated diagrams for the xy - recorder	26, 28

1. Introduction, Description

The interference measuring receiver FCKL 1528 is a fundamental tool to measure interference voltage, interference field strength, interference current, antenna voltages and so on with detectors according to quasi-peak, peak and average.

In contrast to spectrum analysers or communication receivers with added "interference measurement" the FCKL 1528 *was especially designed for the requirements of interference measurement.*

It combines the advantages of classic analogue front panel operated receivers such as

Clarity and comprehensibility of the system

Handiness

Reliability

Reading by meter or xy-recording

with the **advantages** of computer control by efficient and cheap PCs such as

Menu guided software

High dynamic range using AUTORANGE

Introduction of masks

Introduction of antennas

Value added graphics by lin/log-conversion and zoom

Easy documentation.

In both operation modes the special requirements of interference measuring are covered. Measuring pulses as slow as single click is possible according to the standards.

In addition **VARISCAN** permits the safe and time saving recording of any spectrum in the "slow" detector modes CISPR-Quasi-Peak, CISPR-Average and CISPR-RMS by adjusting the scan speed to signals recognised in advance.

The result is *continuous recording* without using the peak detector to decide.

A second thought was made to protect the receiver from dangerous overload when used with a L.I.S.N.. Some powerful devices under test are able to deliver high power to the receiver. Potential damages are avoided or restricted to relatively cheap components. For this reason a 10-watt-power attenuator with 10 dB attenuation can be switched into the signal path directly behind the r. f.-connector.

If used with a remote control Schwarzbeck L.I.S.N. (NSLK 812x rcfm, rcps) the system is protected by a complete safety net in the receiver, the L.I.S.N. and the software, even if the components are connected to different mains and are switched on and off at different times.

2. SAFETY-INFORMATION, Mains Voltage Selector/Fuse

The receiver is operated with mains voltages from 110 V (100 V) to 240 V. Even if the receiver is open, no dangerous voltages can be touched because of the fact that the power supply is a separate box and only low voltages are used outside. Before opening the power supply disconnect mains!

The power supply is a separate unit together with the rear side cooler. It is connected to the mains via a 3 wire cable with one wire as safety ground. The standard cable uses a yellow/green colour for safety ground.

This safety ground wire connects the receiver's metal cabinet with the safety ground of the mains. This means that German VDE standard "Schutzklasse 1" is fulfilled.

In the power supply the safety ground wire is connected to the receiver's ground via a ferrite choke. This was made to avoid rf coupling because of multi grounding. The wire used for the choke has the necessary gauge for the current needed for the fuses to blow. The transformer was designed according to the rules of the German standard "Schutzklasse 2" for isolated appliances.

Primary and secondary windings are located on separate parts of the coil former and therefore have a very good isolation and a very small cross capacitance. Both mains wires are protected by fuses, which can be changed only by using a tool. Mains connector, fuse holder and voltage switch are one unit. The wire from here go to the transformer via the on/off switch. The wires are double isolated and secured by an epoxy holder.

The mains switch is also located in the power supply unit and driven by an isolated shaft coming from the front panel. In the receiver therefor there are no high voltages. The primary part of the power supply is tested for 4000 volts ac eff. 50/60 Hz.

To comply with the regulations of most countries, the receiver was designed for the use with a safety ground connector. If for some reason a safety ground connection is not wanted, we recommend total isolation by an isolation transformer (100 VA).

If the mains plug of the standard cable has to be changed because of some different foreign standard, it is very important to connect the yellow/green safety ground to the safety ground of the mains. This connection has to be checked carefully! In the final system there is usually a second grounding via the L.I.S.N., which itself is grounded via the metal wall of the shielding room.

Problems because of this second grounding will not occur because of the ground choke, which is introduced in the safety ground wire of the receiver.

Extreme care is necessary when connecting a L.I.S.N.: According to CISPR-(16) and VDE(0876) they use high grounding capacitances. Using a NSLK (50 Ω // 50 μ H + 5 Ω) this ground current can reach up to 0,6 A. Such a L.I.S.N. must therefor be grounded before connecting to mains. Grounding is possible either by connecting the ground clamps of the L.I.S.N. to the metal wall of the shielding room or by connecting the rear safety ground clamp with the mains ground. The NSLK-types use a fixed mains connector which makes a safety ground connection when plugging in. Double safety is given by the connection to the metal wall of the shielding room already made before. FI-switches which sense the current on the safety wire are not useful because of the ground current of the L.I.S.N. This would result in a instantaneous disconnection. An isolation transformer can be a solution if such problems occur.

Only qualified personnel is authorised to connect a L.I.S.N.!

Mains Voltage Selector/Fuse Holder

Disconnect mains cable before working on voltage selector/fuse holder!

The receiver uses a linear regulator power supply with a conventional transformer at the input to avoid any interference problem common with switching regulators. The voltage selector combined with the fuse holder at the rear panel (Page 14) has to be set to the local mains voltage. Different mains voltage leads to different supply current, so there are two different fuse-currents to choose. Remove the holder box with the yellow mains voltage field by pushing the lever. Insert the correct fuses.

Insert the holder box in the correct orientation for the mains voltage.

3. FCKL 1524 Controls (Front panel)

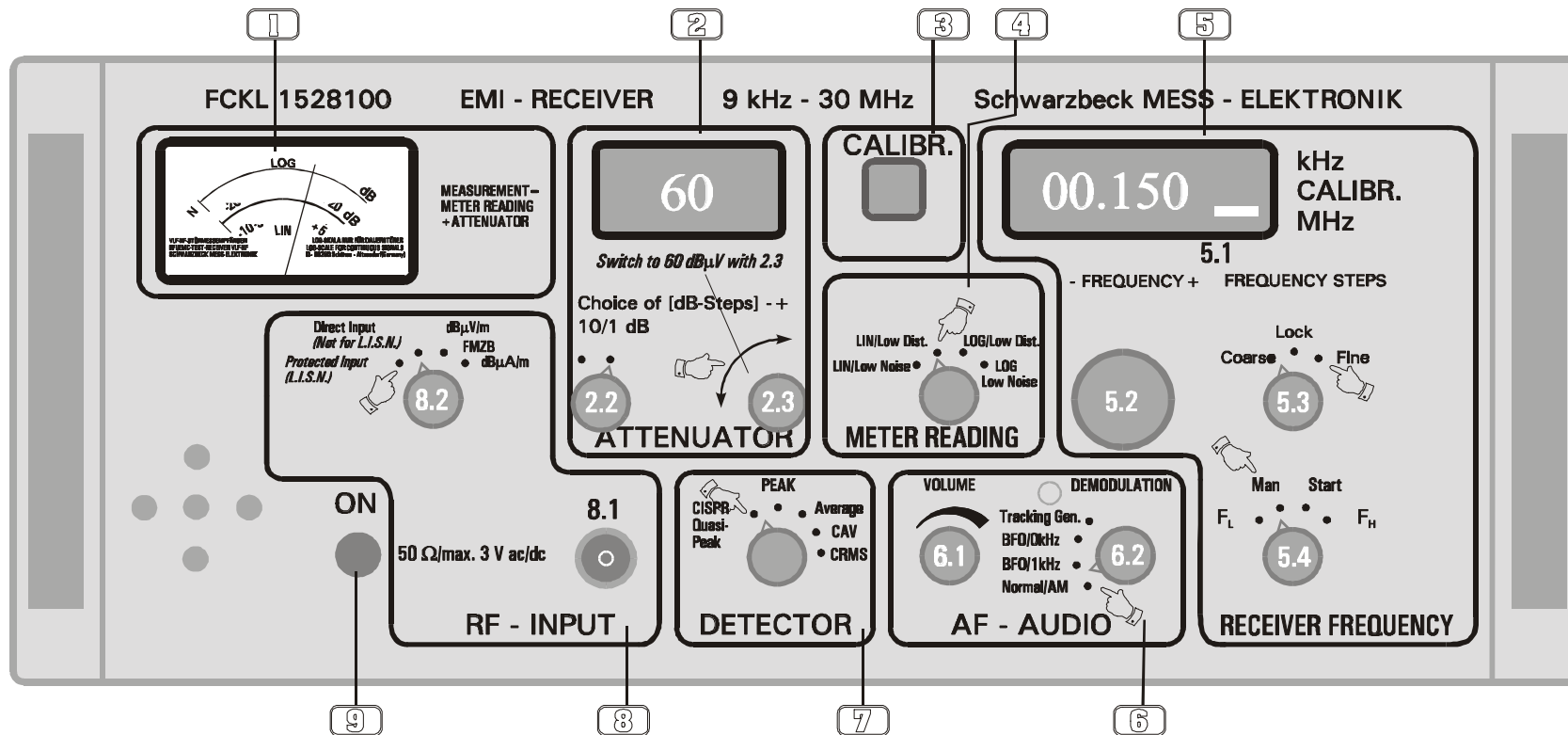

The front panel is divided into 8 areas, which unite important controls and displays.

They are as follows:

- | | | |
|-----------------|-------------------------|-----------------|
| (1) Meter | (4) Meter Reading | (7) Detector |
| (2) Attenuator | (5) Receiving frequency | (8) R. f.-Input |
| (3) Calibration | (6) A. f.-Audio | (9) Mains ON |

(1) METER-area

Reading of the interference voltage dB μ V.
Upper scale: Log. range of more than 50 dB
for an overview (linear dB-scaling).
Lower scale: linear voltage scaling,
dB-scale non linear.

(6) AF-AUDIO-area

Volume control by (6.1).
Rotary switch (6.2) selects audio demodulation.
AM demodulation is norm.
BFO position makes unmodulated sine wave signals audible.
Use position 1 k for band A.

Switch off Tracking Generator for Interference Measurement to avoid wrong results!

(2) ATTENUATOR-area

7-segment-display 3 digits (2.1) for attenuation
in dB(μ V) under consideration of rf input
switch and if attenuation. Rotary Encoder (2.3)
changes attenuation in 1 dB or 10 dB steps
as selected with rotary switch (2.2) .

(7) DETECTOR-area

Selects detector for the meter,
Left: CISPR Quasi-Peak QP
Next cw: Peak PK
Next cw: Average AV
Next cw: CISPR-Average CAV
Right: CISPR-RMS CRMS

(3) CALIBRATION-area

Push the key for semi automatic calibration of
the amplification. Click for calibration. Push
continuously for check of calibration at the meter.

(4) METER READING-area

Rotary switch combines both Lin/Log-Y, Lin/Log-X
Low Noise / Low Distortion. Left part for Lin X/Y,
right part for Log x/y reading.
For continuous signals Log, Low Noise possible.
Use Lin Low Distortion for slow pulses.

(8) RF-INPUT-area

BNC-rf-connector (8.1) (50 ohms unsymmetric input)
from L.I.S.N., probe or magnetic antenna.
The input switch (8.2) matches the source to the input.
Left: Protected input for L.I.S.N. and probe.
An internal 10 dB-power attenuator protects the
receiver from dangerous overload.
Left centre: Direct input for highest sensitivity.
Attention:
Receiver may be damaged by overload!
Do not connect L.I.S.N. or probe in this position!
Right centre: Position for magnetic antenna FMZB 1516/17 with
measurement in dB μ V/m (fictitious el. field-strength)
Right: Position for magnetic antenna FMZB 1516/1517with
measurement reading in dB μ A/m (magn. field-strength.)

(5) RECEIVING FREQUENCY-area

The display (5.1) shows receiving frequency with 5-digits.
The significance is different for band A / band B.
The top and bottom segment of the right end digit
together with the decimal point define - kHz - for
band A and - MHz - for band B. The centre segment is
turned on during the calibration.
The frequency is tuned by the rotary encoder (5.2).
The rotary switch (5.3) chooses the frequency steps
They are different for band A and B. Frequency input
is locked in the centre position.
Rotary switch (5.4) chooses manual or scan operation.
Edge positions preset left or right margin
(9kHz, 30MHz) for the xy - recorder.

The dB μ V-reading (2.1) includes the factors for the protected input,
FMZB 1516/17and if attenuation (3).

(9) Mains switch ON

***The receiver can be ordered with built in IEEE-interface. If no bus
is connected, the interface switch on the back of the receiver must be
in the off position. This is the case if the red "eye" is invisible.***

4 FCKL 1528 Displays and controls, description

4.1 Reading of the interference voltage in dB μ V

Analogue reading of the inference voltage according to the detectors in dB over 1 μ V.

If the attenuator (2.2) and (2.3) is set to 0 dB, the meter reading is directly in dB μ V in a 50-ohm-system, assumed that the input switch (8.2) is in the direct input position and switch (4) is in one of the centre Low distortion positions.

The upper meter reaches from -25 dB to +25 dB with good linear dB-scaling. This means a logarithmic voltage reading which is related to 0 dB in the centre of the scale. This logarithmic overview range is active, if switch (4) is in one of its right hand positions. This overview range permits quasi peak measurements, but there are limitations when very slow pulses occur and the reading is more than +10 dB on the meter.

Because of the fact that the logarithmic scale goes down to -25 dB, there is a basic reading caused by noise for Low distortion (4).

As this noise floor is very low, this is no restriction for practical measurement.

The lower meter gives a linear voltage reading. Because of the logarithmic law between the dB level and the voltage the density becomes higher and higher on the left side.

The definition is very high in the range between -5 dB to + 6dB.

This linear voltage range is best choice for high precision measurements based on the comparison between the signal to measure and the calibration signal.

The input signal is attenuated down to the level (2.2) and (2.3) of the internal calibration signal.

4.2.1 Attenuator display (attenuation in dB μ V)

This 4 digit display (3 digits plus sign) is the result of the attenuation of the step attenuator (2.3), the high power 10 dB attenuator at the input (8.2) and the 20-dB i. f.-attenuator, which is active in the extreme left and right positions of the switch (4).

This dB-number plus meter reading is the interference voltage in dB over 1 μ V according to the detector standards.

If the magnetic antenna FMZB 1516 is used and the input switch (8.2) is in the right position, the reading is dB over 1 μ A/m or in the equivalent electric field-strength in dB over 1 μ V/m. In the case of the magnetic field negative dB μ A/m-numbers can occur.

4.2.2 10 dB-steps of the input attenuator

With the 10 dB-step attenuator the desired level range of the receiver is controlled. The dB number visible in (2.1) corresponds to the 0 dB-marker in the centre of the meter scale and to the 0 dB horizontal centre line of the xy recorder diagram.

The left end of this line touches a small rectangular area, in which this dB number has to be written.

At the right end of the line the relative level has to be introduced.

If the input switch (8.2) is in the position "protected input", the range of the 10 dB step attenuator is from 10 dB to 100 dB (plus 5 dB from the 1 dB-attenuator).
If switch (4) is in the low noise position, the presettable range is from 30 dB to 120 dB and more if the 1 dB step attenuator and the meter are considered.

If for special purposes a higher sensitivity is needed (down to $-10 \text{ dB}\mu\text{V}$), the input switch (8.2) has to be set to direct input.

In this case the 10 dB high power input attenuator which protects the receiver is not active.

The lowest number in (2.1) will then be 00 dB, the meter theoretically can be used down to -10 dB.

The step attenuator of this receiver is binary coded with a maximum attenuation of 95 dB. A control logic with "soft locks" keeps the attenuator well within its limits, even if the rotary encoder 2.3 is "overturned".

4.2.3 1 dB-steps of the input attenuator

With the 1 dB-step attenuator a measurement based on direct substitution is possible by comparing an interference voltage to the internal pulse calibration generator (3) and using the lower meter scale.

In the right position of the rotary switch (2.2) the rotary encoder (2.3) increments or decrements the attenuator in 1 dB-steps until the same meter reading (for example.

0 dB centre in the lower line range) is reached.

Using this method ultimate precision is obtained, which cannot be surpassed by any other measuring method.

The precision of the attenuator, specified in the data sheet with $\pm 0,5 \text{ dB}$, usually is better than $0,3 \text{ dB}$.

The "soft locks" mentioned above are also used with 1 dB-steps, but provide 5 dBs more attenuation (In the 10 dB position of (2.2) the 10 dB-digit is set to 0).

4.3 Calibration key

Initiates semi automatic pulse calibration of the receiver's amplification.

If band A is active by choosing the frequency in the vlf-range 9 kHz-150 kHz, calibration is done with 200 Hz bandwidth and a pulse frequency of 25 Hz.

In the range 150 kHz-29.999 MHz (band B) bandwidth is 9 kHz and pulse frequency 100 Hz.

Internal calibration is always done with the quasi peak-detector, so it can always be checked on the meter.

After switching on the receiver, there is always a priority calibration after 1 second.

Always before measurements and repeatedly during warm up a calibration should be made.

During calibration the meter reading approaches 0 dB centre without reaching it.

For special purposes continuous pressing of the calibration key can be useful.

The most important case is the adjustment of the xy recorder.

4.4 Meter reading

This rotary switch combines both lin / log y and low noise / low distortion in 4 positions. *The low noise positions* reduce internal noise by nearly 20 dB and therefore give a better reading in the left part of the meter (1), especially in the log y mode.

On the other hand also the test signal is attenuated, which has to be compensated for by reducing the input attenuator to get the same reading.

This means that the receiver's input gets more voltage which could result in compression or overload.

Narrow band signals and fast pulses can be measured in this way, but not slow pulses.

The switch positions with log y give an overview range of 50 dB in dB-linear scaling with the upper scale. This kind of diagram is wide spread, especially with xy-recorders.

Special care has to be taken if slow pulses are present. For this reason prefer the lin y / Low distortion position of switch 4, because it treats pulses right without any restriction.

If an overview is desired and no slow pulses are present, the position low noise / log y is ideal.

Choosing lin/log y also determines lin/log x (frequency).

A linear frequency scaling is a disadvantage for band A.

For special purposes you can expand it by higher amplification of the xy recorder.

The above difficulties to match the receiver to an unknown spectrum in order to get a diagram is completely avoided in a PC controlled system.

The FCKL 1518 together with the Schwarzbeck software "is doing it all by itself".

4.5 Frequency-area

4.5.1 Frequency display

This display consists of 6 pieces 7-segment-digits.

Five of them give the frequency number and one of them (right corner) shows the status.

This gives easy and precise frequency reading especially for interference measurement purposes.

Only the relevant digits are displayed.

In band B the most significant digit is 10 MHz, the lowest significant is 1 kHz.

In band A the most significant digit is 100 kHz, the lowest significant is 10 Hz.

Tuning downward from band B below the basic limit of 150 kHz (00.150), nothing changes until 100 kHz (00.100) is reached.

This info range is not related to any standard and also the amplification of the receiver decreases rapidly because of input filtering.

Do not calibrate (3) in this range, because this leads to errors on other frequencies!

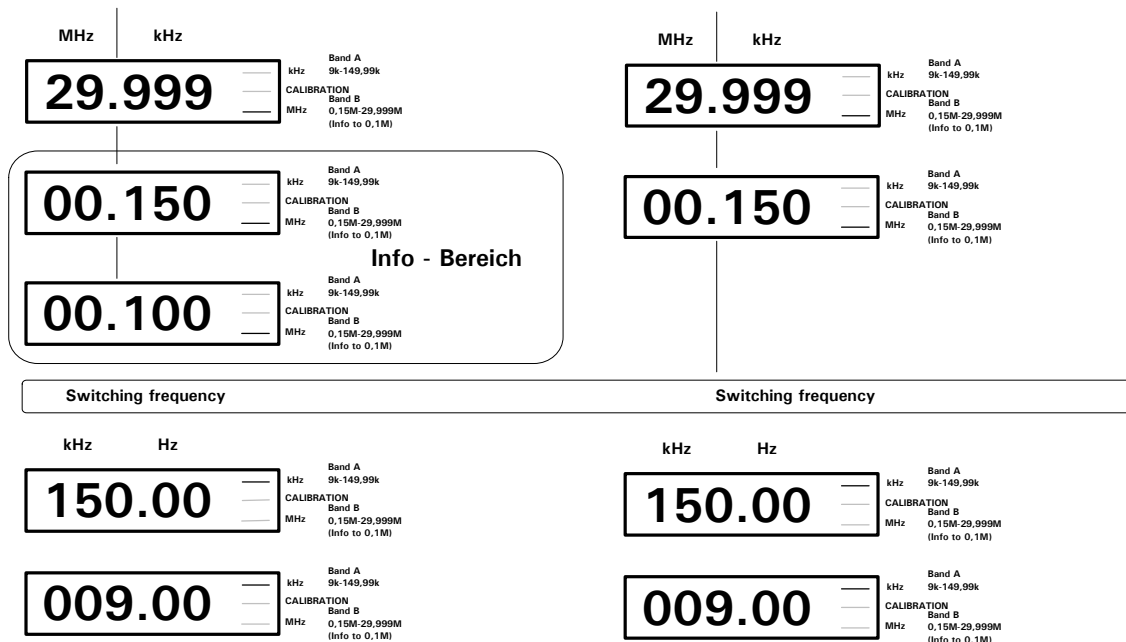

Tuning direction band B to A

Tuning direction band A to B

4.5.2 Frequency encoder

The manual frequency tuning is made by rotating the frequency encoder. Turning cw increases, ccw decreases frequency. The frequency steps are chosen by the rotary switch (5.3).

4.5.3 Frequency steps

This rotary switch determines, if the frequency decoder (5.2) controls the first or second digit of the display or if the input is locked. The significance of the digits depends on the frequency range the receiver is in. By that strategy, the tuning behaviour is automatically optimised for the different bandwidths in the 2 bands. Already in manual mode this is a nice feature, but it's ideal when working with an xy recorder, because the complete range can be scanned without any switching.

FREQUENCY STEPS

Coarse Lock Fine



Coarse: 100 Hz - steps in band A 10 kHz - steps in band B
 Fine: 10 Hz - steps in band A 1 kHz - steps in band B

The position of this switch determines both manual tuning and automatic scanning (think of lock position if nothing happens!)

To detect narrow band signals steps have to be chosen "Fine". This is especially true if xy-recorder is used. For an overview or frequency hopping "Coarse" is faster.

4.5.4 Rotary switch

to select manual or automatic tuning and xy-recorder positioning. In the Man position the receiver's frequency is tuned by the encoder. In the Start position a clock generator does this tuning work. *The scanning procedure always begins at 9 kHz or at the frequency tuned with Man and is only possible for rising frequency.* The 2 edge positions set the frequency to 9 kHz or 29.999 MHz respectively. This makes life easier when adjusting the xy recorder to a diagram.

4.6 AF/AUDIO

This area contains both a. f.-volume control **(6.1)** and demodulator switch **(6.2)**. The a. f.-volume control works just like in a radio receiver, but it has to be considered, that especially in band A the loudness sometimes is poor. The reason is that the very narrow bandwidth of 200 Hz can only deliver very low a.f. frequencies to the loudspeaker which is too small for this purpose. Often the operator compensates for this low volume by increasing a.f. amplification with the volume control. This results in overloading and by that harmonic distortion is produced. This harmonic distortion then gives higher volume. In the norm position of the demodulation switch input signals are demodulated as if they were amplitude modulated, which is the case for most of the signals in this frequency range, especially broadcast stations. Pulse noise and calibration signal can be monitored well in this position. The positions BFO 0k and BFO 1k are useful if unmodulated narrow band signals occur. Being unmodulated, there is no information to listen to. Only some variation in basic noise can be monitored. If a BFO is in use, the differential frequency between input signal and receiving frequency occurs. This differential frequency is exactly the difference between these two frequencies if the switch is in the 0 k position. If the difference is 0 (zero beat) both frequencies are equal. For the narrow bandwidth of band A an audible difference frequency cannot appear. The problem is solved by using BFO 1k position. Both frequencies are equal if a 1 kHz difference frequency is heard. Due to the more and more automatic measurements these considerations seem to be less important. But it is still very important especially when working without shielding room to verify a signal to know if it is interference or broadcast. Also the acoustic signature of a signal gives some information.

4.7 Selecting detectors, QP, PK, AV, CAV, CRMS

Select detectors according to the standard.

Continuous sine wave signals give the same reading on all detectors.

Changing signals and pulses give different readings.

4.7.1 CISPR Quasi-Peak QP

This detector has a pulse weighing characteristic which considers the annoyance.

If single clicks or slow pulses are to be measured, choose lin y/ low distortion of switch 4. Highest precision is obtained, if both attenuators (2.2) and (2.3) are used to adjust the signal to the 0 dB marker of the linear (lower) scale. The precision is then better than required. The measurement reading can be done in the display (2.1) for 0 dB (centre) meter reading.

4.7.2 Peak PK

Centre position of switch (7) gives reading of the unvalued peak voltage.

The Peak Detector has an extremely short charge time constant and is self-resetting.

The measurement is the peak value, related to the bandwidth, based on the calibration of the effective value of a sine wave.

4.7.3 Average AV

In this position the average of the demodulated i. f. signal is measured.

A time constant is used to give a constant reading for pulses with repetition frequencies >100 Hz. This Average Detector behaves like the classic Average detector which has been familiar to the EMC - community for the last 50 years.

4.7.4 CISPR-Average CAV

Just like the classic AV, but with a critically damped second order low pass filter with a time constant of 160 msec. The pulse weighing for fast pulses is the same, but the behaviour for slowly changing (narrow band) signals is completely different.

4.7.5 CISPR-RMS CRMS

This detector has a weighing function which considers the effects of disturbance to digitally modulated signals.

Basically it uses a RMS - Detector with a specified corner frequency followed by critically damped second order low pass filter with a time constant of 160 msec.

5. First steps

5.1 Front panel operation, manual tuning

Attention: Read safety informations page 2 very carefully. Before connecting receiver to mains, select mains voltage and fuse-current on the rear pannel voltage selector/fuse holder.

Attention: The receiver can have a built in IEEE - interface. Front panel operation is only possible if the rear switch is in the off-position. This switch is off if the "red eye" is invisible.

- A) Set all switches to the position marked by the hand-symbol in the picture on this page.
Switch 2.2 in the left position, turn 2.3 until 60 dB μ V is reached as attenuator reading.
Set the A.F.- volume in half position.
- B) Switch on the receiver by pushing (9).
- C) About 1 second after switching on a pulse is heard. The meter reading approaches centre (0 dB) and then returns to the left end of the scale. This was the automatic priority calibration with 100 Hz pulses according to band B 150 kHz.

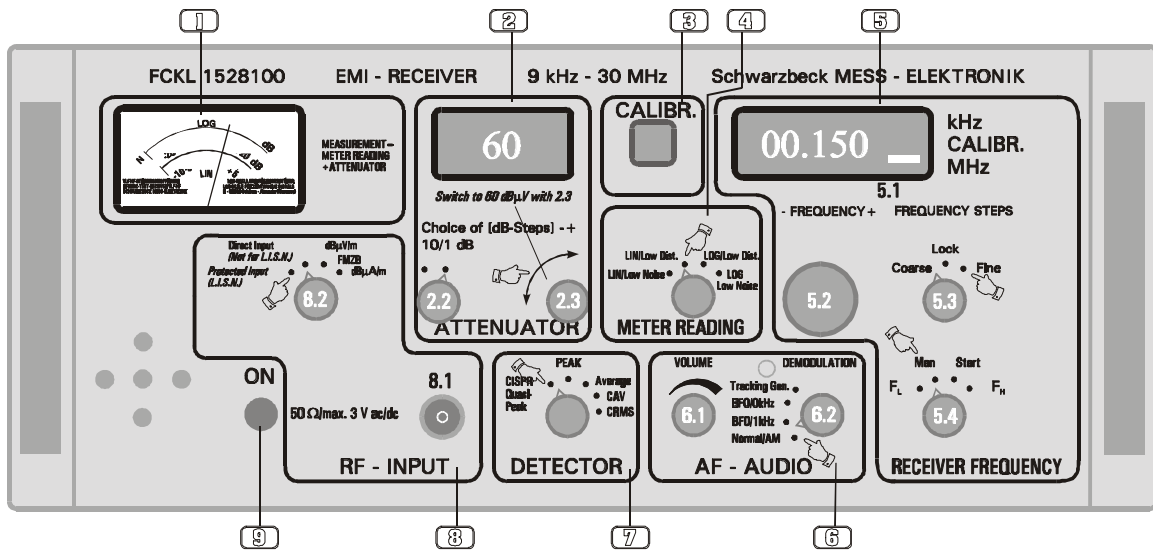

The receiver is now ready to use and frequency is tuned by rotating the encoder (5.2).

The steps can be selected with (5.3) fine or coarse.

Fine permits narrow band signals to be tuned easily. Coarse is ideal for broad pulse spectrums, and frequency hopping.

For overviews it is ideal to choose Log. indication with Low Noise (4) and reading the upper meter scale (1).

If the frequency is tuned with the encoder (5.1) from 00.150 MHz (150 kHz band B) in direction to lower frequencies, the receiver switches to band A at 00.100 MHz (100 kHz), to give to the user an information below the frequency limit (info).

Then follows the change to band A and the frequency display changes to 150.00kHz.

The right lowest significant digit is then 10 Hz! If the frequency is increased, the frequency changes to 00.150 MHz / band B.

In the right corner of the frequency display (5.3) the upper or lower segment shows band A or B.

After this change between band A/B a recalibration is good practice (3).

Appendix Pages 12-28

6 Front panel operation, automatic scanning

A) The automatic scanning is useful for recording a spectrum or to get an overview. For these purposes it is more comfortable than the manual tuning.

A look ahead i. f.-analysis (VARISCAN) adapts scan speed to the spectrum ahead. Highest scan speed is chosen for broad band spectrums and slowest scan speed for narrow band signals.

VARISCAN is always active if automatic frequency scan is chosen.

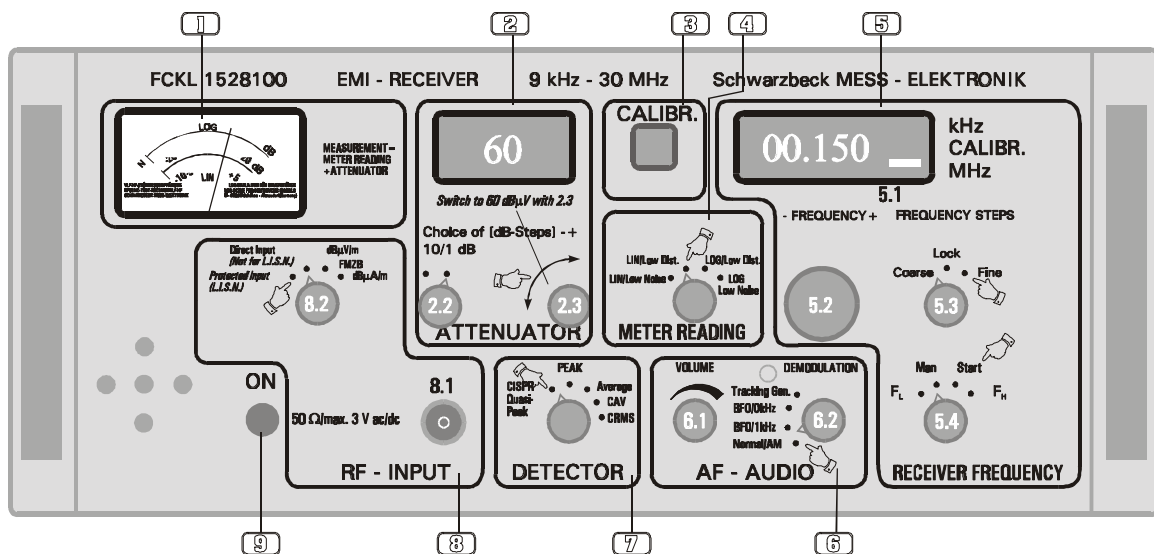

B) Set steps to Fine with (5.3), which is recommended by the arrow. This means that there are 10 Hz-steps in band A and 1 kHz-steps in band B.

C) For overviews choose log. indication together with Low Noise (4). Use the meter scale (1).

D) Set rotary switch 5.4 to the Start position. In the edge positions 9 kHz or 29.999 MHz will be presettet to adjust xy-recorder.

E) The automatic scanning begins. You can stop scanning and go on manually anytime with (5.4) without any restrictions.

7 Automatic scanning and recording with xy-recorder

A) One advantage of this receiver is the easy recording of interference spectrums, for example with xy-recorders or storage oscilloscopes.

Usually the xy-recorder will be used. A look ahead if analysis (VARISCAN) adapts scan speed to the spectrum to come. Highest scan speed is chosen for broad band spectrums and slowest scan speed for narrow band signals.

VARISCAN is always active if automatic frequency scan is chosen. A cable connects the xy-recorder to the rear side 25-pin sub-d- connector of the FCKL 1528. The xy-recorder receives the analogue voltages for frequency and interference voltage.

There are 2 connectors for the frequency and 2 connectors for the y amplitude. A DIN-connector is there for pen lift control.

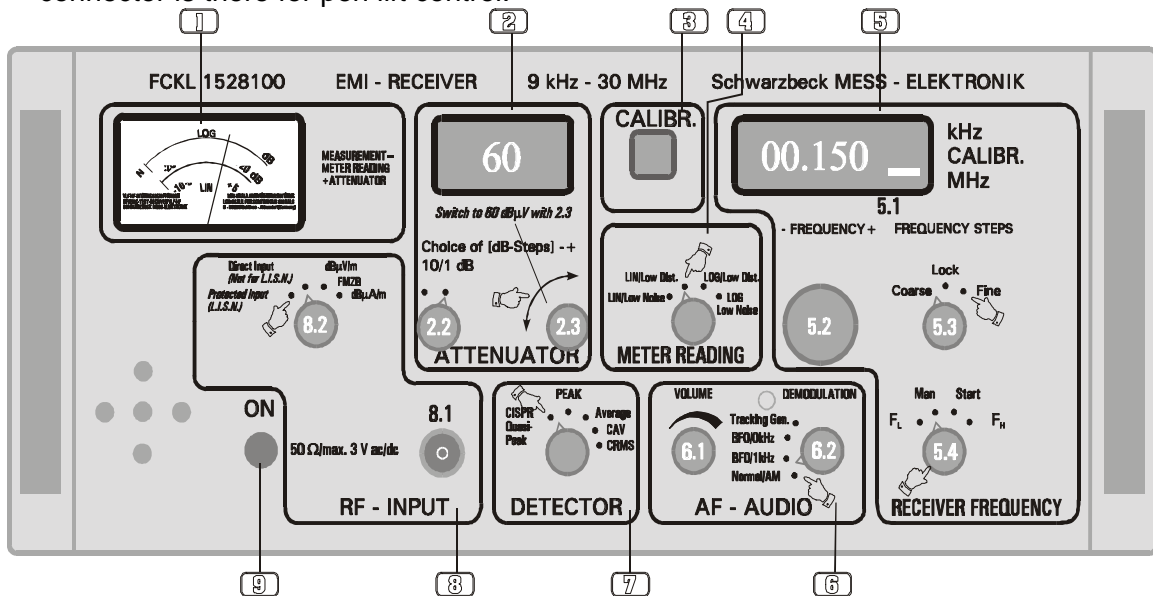

B) The connectors of the cable have writings. The black connectors belong to the sockets of the xy-recorder indicated with a minus. The x socket (frequency) of the recorder belongs to the red connector, the y-connector (amplitude) belongs to the yellow (voltage, dB).

The 3 pin DIN connector is responsible for pen up / pen down control. This DIN connector fits directly into xy-recorder delivered by our company. On the control panel of the xy-recorder both sensitivity switches are positioned to 0,1V/cm and the other switches to "Var." (=variable sensitivity).

By toggling the rotary switch (5.4) between the 2 edge positions, the receiver toggles between 9 kHz and 29.999 MHz and the pen of the xy-recorder toggles between left and right edge.

Now one of the prefabricated diagrams is positioned on the xy-recorder and electrostatically fixed (switch "chart"). Position the receiver with (5.4) to 9 kHz (F_L). The pen is adjusted by the x zeroing control (hor. double arrow) to the 9 kHz frequency line. Set (5.4) to 29.999 MHz (F_H). The pen runs to the 30 MHz line. Adjust the pen to this line precisely by controlling the "Var."-control (=sensitivity). Adjustment of the dB scaling is similar. Without input signal (Low Noise position reduces base line noise) the "y" zero is adjusted to the bottom line of the diagram. With permanent calibration signal adjust "var."-control (=y - sensitivity) until the centre 0 dB(rel.)-line is reached. Without calibration signal for 9 kHz point A and for 30 MHz point B must be covered.

* Switching should be made without stopping at Start to avoid starting the scan procedure.

8 Rear side (Description, comments, warnings)

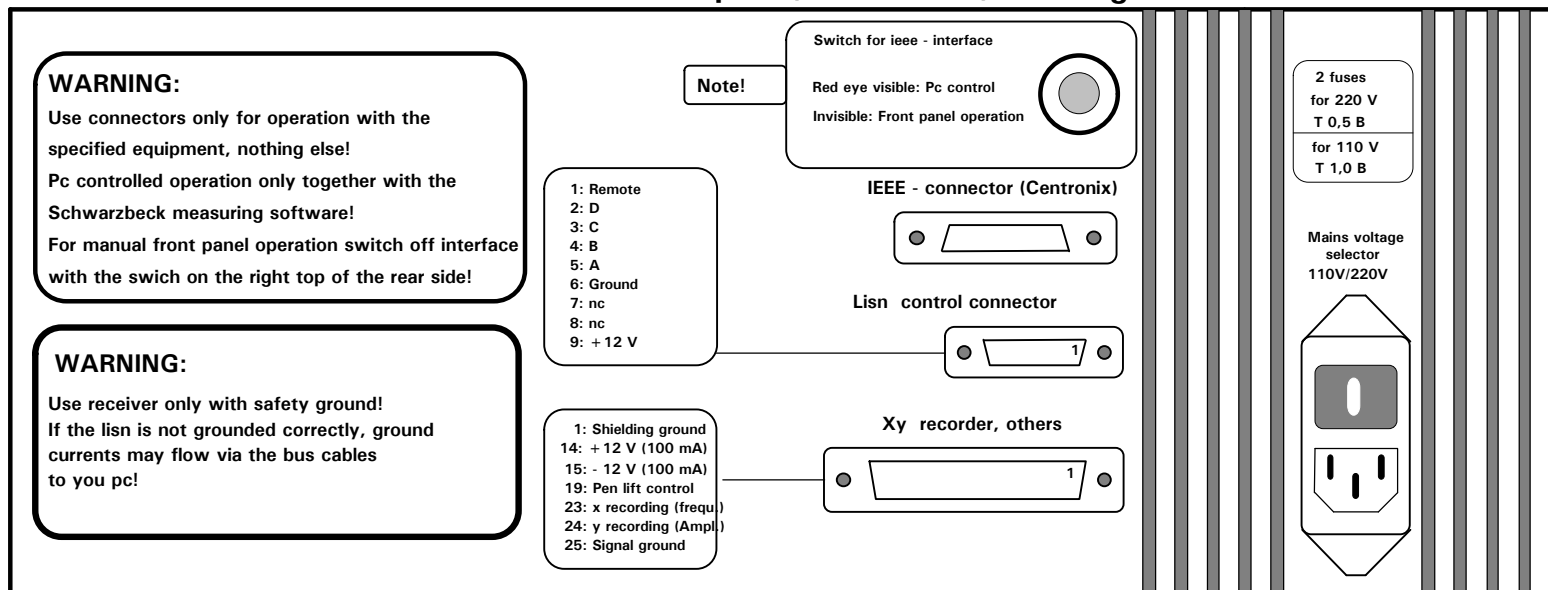

DCBA	Function	xy recorder, others	IEEE 488 connector
0 0 0 0	no phase	no ground choke	Connected via standard bus cable
1 0 0 0	no phase	no ground choke	y (frequency) lin/log 0 V - 1 V to INES IEEE card built in PC..
2 0 0 1	Phase 0	no ground choke	
3 0 0 1	Phase 1	no ground choke	y (amplitude) lin 0 V - 0,5 V - 10 V
4 0 1 0	Phase 2	no ground choke	Centre meter 0,5 V
5 0 1 0	Phase 3	no ground choke	
6 0 1 1	no Phase	no ground choke	y (amplitude) log 0 V - 0,5 V - 1 V
7 0 1 1	no phase	no ground choke	centre instrument 0,5 V
8 1 0 0	no phase	with ground choke	
9 1 0 0	no phase	with ground choke	pen lift: Open collector in series
A 1 0 1	Phase 0	with ground choke	with 1 k resistor to ground
B 1 0 1	Phase 1	with ground choke	for pen down.
C 1 1 0	Phase 2	with ground choke	
D 1 1 0	Phase 3	with ground choke	
E 1 1 1	no Phase	with ground choke	
F 1 1 1	no Phase	with ground choke	

Remote: Logic 0 local (manually)/logic 1 remote (PC control) 0 V / 5 V

9 How to connect and adjust the xy-recorder

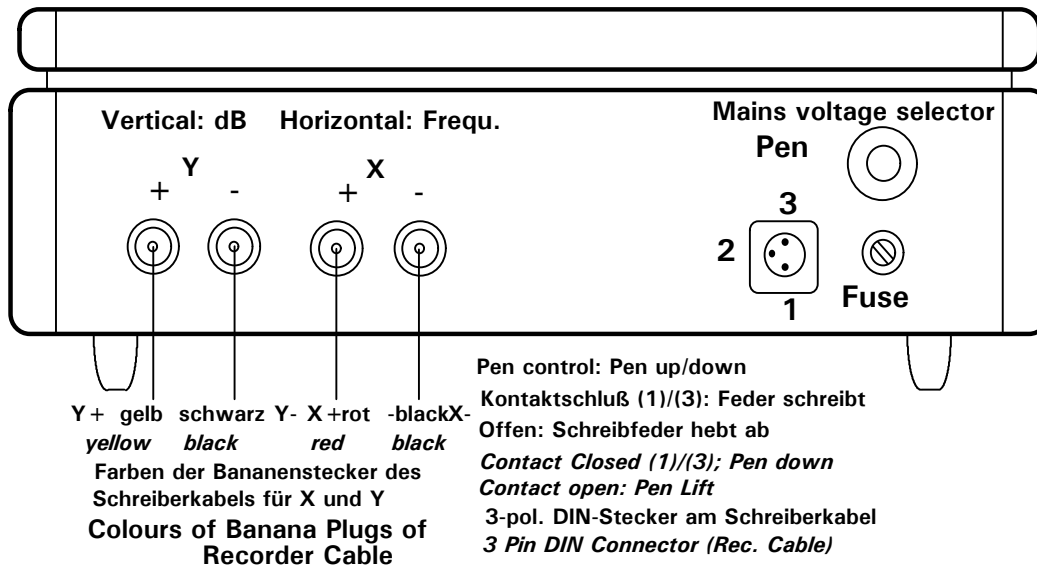

(A) NETZSCHALTER Aus/Ein Power/Mains Switch

(B) Schalter Off/Chart/Pen, Off: Papier frei, Chart: Papier wird Stat. fixiert, Pen: Feder a. Papier

Off: Paper loose, Chart: Paper fixed, Pen: Pen down
(C) VAR.X: X-Verstärkung Amplification X (Control (frequ.))
(D) Schalter VAR/CAL, Einstellen auf VAR Sw.: Set to "VAR"
(E) Drehschalter: 0,1V/cm Rotatable Sw.: Set to 0,1V/cm
(F) Nullpunkt X (9kHz) Zero X, set at 9kHz
(G) VAR, Y Y-Verst.(dB) Amplification Y Control (dB)
(H) Schalter VAR/CAL, Einst. auf VAR. Sw.: Set to "VAR"
(J) Drehschalter: 0,1V/cm Rotatable Sw.: Set to 0,1V/cm
(K) Nullpunkt Y (kleinste Spg.) Zero Y, set to lowest dB line

Nullpunkt X (Regler F) auf 9 kHz (Punkt A, Schalter 5.4)
Verstärkungsregler X (VAR. X Regler C auf 30 MHz (Punkt C, 5.4)
Nullpunkt Y (Regler K) auf unterste Pegellinie justieren, wenn kein
Signal und kein Rauschen vorhanden ist (ZF +20 dB)
Kalibriertaste (3) dauernd drücken bei (5.4) 9 kHz. Wenn Instrumentenzeiger
auf 0dB, mit Regler (G) VAR. Y Schreibst. a. Pkt. B des Diagramms

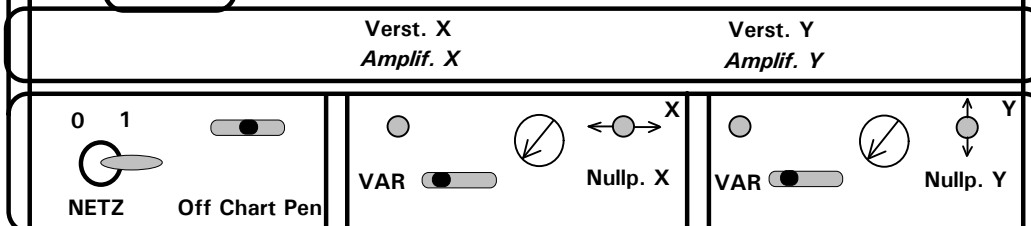

(A) (B) (C) (D) (E) (F) (G) (H) (J) (K)

XY-Recorder Controls: Zero X (Control F) adjusted until pen is at the left-hand rim of the recording pattern 0 9 kHz Pint A Switch 5.4.

Amplification Control (X) (= VAR. X, Control C): adjust to right hand rim of recording pattern with highest frequency (29.999 MHz, Point C Sw. 5.4). Readjust until C and A are

Zero Y (Control K) adjusted to lowest voltage (downmost) rim of the recording pattern with no signal and no noise on receiver (+20 dB I. F. Sw. 4). Press Calibrator Key (3) on receiver continuously with switch (5.4) on 9 kHz, until meter reading is 0 dB center. Adjust pen to point B with VAR. Y control (G).

10 Measuring site for interference voltage

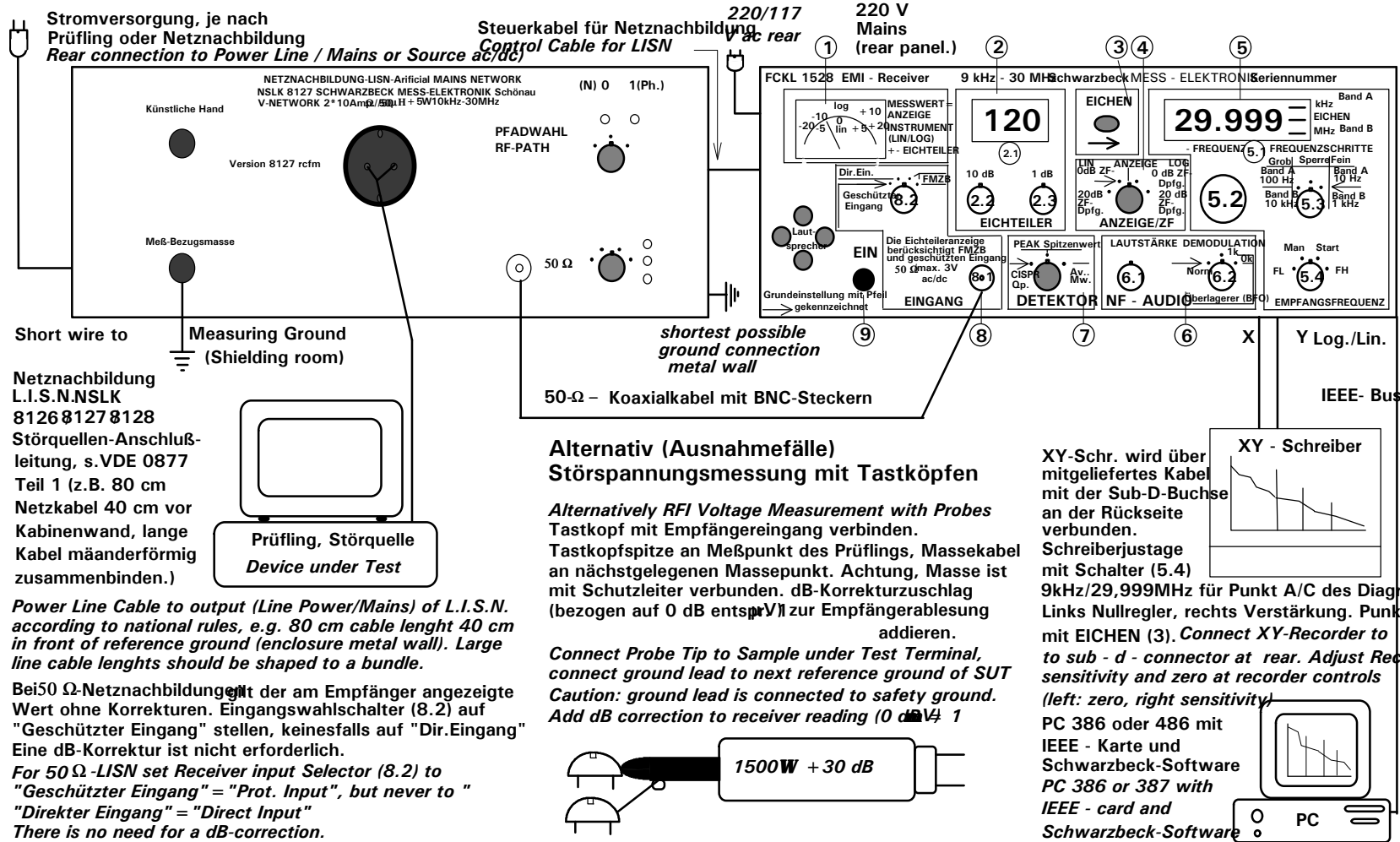

11 Optional Tracking Generator

11.1 What is it good for?

The optional tracking generator produces a signal on a frequency which is equal to the receiver frequency. Transmitter and receiver come together as a transceiver. Being on the same frequency all the time makes tuning and measuring very easy and fast.

11.2 How does it work?

The input frequency of the receiver is mixed several times until the audio frequency band is reached. The tracking generator does the same in the opposite sense, it mixes frequencies until the final frequency is reached, which is equal to the receiver frequency. Additional filtering and amplification give a strong (1V/50 Ω) clean signal.

11.3 What is it good for?

Tracking generator and interference measuring receiver together are a powerful instrument to measure attenuation. This is due to the sensitivity, the dynamic range and attenuator precision of the receiver. If as in this case the output voltage of the tracking generator is high (1 V/50 Ω), in theory attenuation of more than 130 dB can be measured. In the real life such attenuation has to be measured not very often and measurement is critical because of the decoupling needed. On the other hand, the high dynamic range available can be used to put in fixed attenuators to improve matching, which improves precision.

11.4 Which are the most important tasks?

11.4.1 Filter measurement

While a part of the interface is already suppressed on the PC-board where it's produced, usually additional filtering is needed in the power supply lines. This filter prevents conducted interference to spread via the mains cable. Filter attenuation is most often given by the manufacturer's data sheet, but it is very helpful to check it in the assembly. This can be done by connecting receiver and tracking generator to the filter's input and output. The level difference is the filter attenuation on the frequency tuned.

11.4.2 Field attenuation between transmitting and receiving antenna.

The attenuation between 2 antennas in a free field area can be calculated, but especially in non perfect areas differences occur. They can be recorded, when transmitting and receiving antenna are connected to the tracking generator and the receiver. In the frequency range from 9 kHz-30 MHz a passive magnetic loop antenna is usually used for transmitting and a magnetic field strength adapter for receiving. It is now possible to record the attenuation via the frequency and check the differences to the calculations. In the same way the effectiveness of shielding and shielding rooms can be measured.

11.4.3 How to calculate the attenuation?

$$\text{Attenuation [dB]} = \text{Transmitting Level [dB}\mu\text{V]} - \text{Receiving Level [dB}\mu\text{V]} - \text{Additional Attenuation [dB]}$$

The transmitting level of the tracking generator is 120 dB μ V.

The receiving level is measured as usual.

Additional attenuation can be 10 dB fixed attenuators on the output of the tracking generator and on the input of the receiver.

Also antenna factors and other transducer factors and attenuation have to be considered.

Measuring Mains Filters it is especially important to use 10 dB fixed attenuators directly on input and output.

The reason is that these filters which are usually measured in a 50 Ω -system, are in no means matched to 50 Ω .

In contrast to filters for communication systems, they are only optimised for attenuation, nothing else.

The attenuators reduce the negative effect of mismatch in the measuring system.

11.5 Where is the r. f.-output of the tracking generator?

On the right side of the rear panel near the top of the power supply cooler the BNC-connector for the tracking generator is located.

11.6 Where is the switch on/off?

In manual (front panel) operation, the tracking generator is switched on/off with the DETECTOR rotary switch.

The on - position is indicated by a flashing red LED.

The tracking generator must only be switched on when it is really needed. EMI-measurement in this mode is potentially erratic.

Using software control the tracking generator is switched on/off in the settings - receiver menu. Software control is very simple and precise because of autoranging.

By that the dynamic range is very high.

Also in the software mode switch on the generator only when it is needed and never for interference measurement.

11.7 Important!

Switch on the tracking generator only when it is really needed.

There are two reasons for this advice.

Reason 1: The narrow interference bandwidth in band A (9 kHz-30 MHz) is too narrow for measurement with the tracking generator, because it makes the system slow.

It is therefore changed to about 4 kHz, which is good for the generator, but bad for standard interference measuring, because it is not standard.

Pulses measured with this bandwidth (tracking generator on) are absolutely wrong.

Reason 2: Any unterminated piece of cable can spoil the laboratory with radiated r.f..

It is useful to work in the low noise mode to extend the meter dynamic.

Use a fixed attenuator on the BNC - connector.

The reduction of output voltage usually is no problem because of the basic high level.

The attenuator works as a protection in every day work.

The power amplifier of the tracking generator uses r. f.-transistors which may be destroyed by high voltage spikes. If it is to be connected to a L.I.S.N. a pulse limiter must be used (please ask for information), otherwise the generator might be damaged.

12 Meter and Meter Reading

12.1. Basics

We consider an EMI-receiver as a frequency selective voltage meter.

Frequency selective means, that only a. c.-voltages of the tuned frequency are measured (within the specified bandwidth). Using the FCKL-receiver in the frequency range from 150 kHz to 30 MHz the bandwidth is 9 kHz (-6 dB).

A common analogue or digital multimeter also measures a. c.-voltages, but the measurement is not frequency selective in the useful frequency range.

This frequency range is limited by the low (some Hz) and high (some kHz) frequency limit, depending on the qualification of the meter in use.

The meter measures the sum, because all voltages within the range are fed to one rectifier.

One single high voltage dominates the measurement.

Weaker voltages on other frequencies don't influence the reading significantly.

The frequency selective EMI-receiver in contrast will show a multitude of voltages with different frequencies separately.

A common multimeter has a basic dynamic range in which different voltages can be measured without changing the range.

To extend the voltage range dividers are used to divide high voltages down to the basic range.

Common multimeters for example have switch positions for 200 mV, 2 V, 20 V, 200 V, 1000 V.

The smallest voltage to measure in the 200 mV-range is 0,1 mV, the highest 199,9 mV. Voltages < 0,1 mV are ignored, voltages > 199,9 mV show overflow.

In contrast to common multimeters which are scaled in V, EMI-receivers use a scaling in dB μ V, which means dB over 1 μ V.

The logarithmic dB-scaling is widely used in signal generators, pulse generators and receivers.

It is for this reason that the attenuator steps of the FCKL are also in dB.

Just like the multimeter the receiver has a basic dynamic range and an attenuator.

If the attenuator is switched to zero attenuation, a noise floor of less than -10 dB μ V is measured in the frequency range 150 kHz-30 MHz using the CISPR/Quasi-Peak detector.

0 dB (centre of the meter scaling) is 0 dB μ V/1 μ V.

The right edge of the linear scale is +6 dB μ V/2 μ V.

The right edge of the logarithmic scale is +26 dB μ V/17,8 μ V.

The attenuator shifts this dB-range into higher voltages, the attenuation has to be added to the meter reading.

This shift can also be made using the low noise position.

This attenuation is not added on the input, but near the output of the receiver and therefore reduces noise.

This makes measurement easier because of reduced noise errors, but it increases receiver loading which can result in errors caused by overload (saturation, compression, intermodulation).

12.2 Meter and Scaling

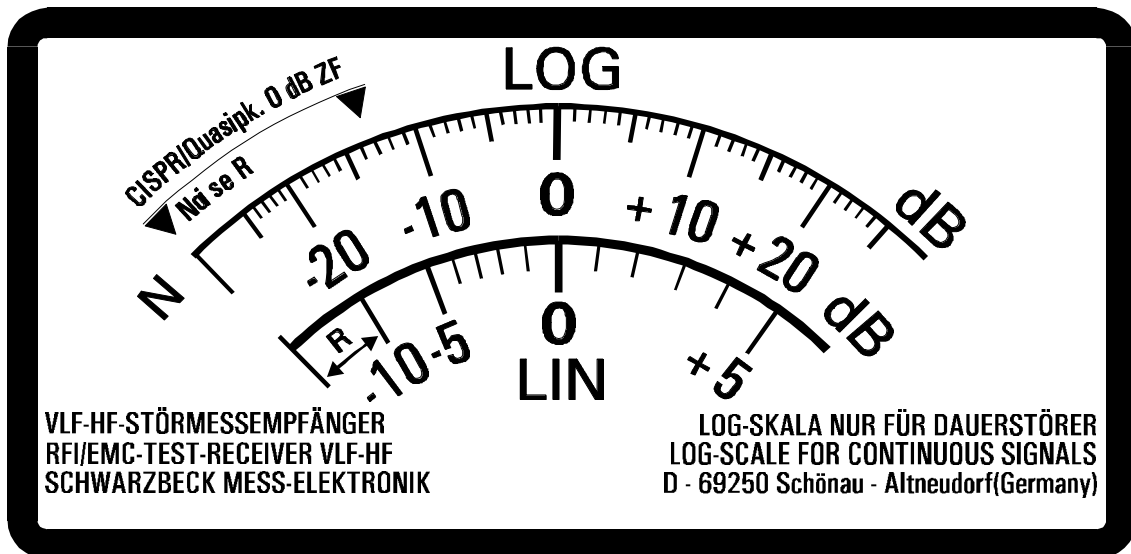

12.2.1 Zeroing

12.2.1.1 Mechanic zeroing of the meter: The indicator (pointer) is adjusted to the N - point on the left side of the meter scaling by turning the screw below the meter window.

12.2.1.2 Electric zeroing: Even when no signal is coming into receiver (coaxial cable disconnected), there are small „idle“ measurements on the meter.

They are caused by the internal noise of the receiver and are different for different receiver settings. These noise reading is absolutely correct and no error.

Any method to avoid this basic noise would affect the measurement of small signals.

In order to prevent misreading caused by noise in the very common case of CISPR Quasi-Peak-Detector, Low distortion and Band B (150 kHz-30 MHz), there is a note on both linear and logarithmic scale.

The noise reading depends on:

A) Linear and logarithmic scale: The logarithmic scale can show smaller signals than the linear one. This means that also the small „Noise Signal“ shows more indicator angle on the left side of the scale.

B) Low distortion) / Low noise): Low distortion shows approx. 20 dB more noise than Low noise. Low noise gives a longer usable scale with the disadvantage of potential (non damage) receiver overload.

C)The frequency ranges Band A (9 Hz-150 Hz) and Band B (150 Hz-30 MHz) use different bandwidths and detector time constants. As a consequence the noise indication in Band A is much lower than in Band B.

D)The 3 different detectors differently convert receiver noise into noise reading. The Peak/Mil-detector shows the highest reading, followed by CISPR Quasi-Peak and Average.

Obviously a multitude of possible combinations lead to different noise readings. It has to be considered that the same noise leads to different scale angles on linear and logarithmic scale, even though this is same reading.

The combination for the smallest noise reading is:

Frequency range: Band A (9 kHz-150 kHz)
 Detector: Average
 I.F. - Att.: Low noise
 (Meter scale: Linear)

The combination for the highest noise reading is:

Frequency range: Band B (150 kHz-30 MHz)
 Detector: Peak / Mil
 I.F. - Att.: Low noise
 (Meter scale: Logarithmic)

Usually CISPR Quasi-Peak is the standard detector.

The tables below show some characteristic noise readings for this detector.

Lin. Scale	Band A	Band B
low noise	very small	about 2 mm (0.1") left of -10dB Point
low dist.	very small	very small

Log. Scale	Band A	Band B
low dist.	about 2 mm right of zero	high, about -14 dB *
low noise	very small	very small

* Using this setting, there may be a possible misreading caused by noise indication. It is a good practice to listen to the sound coming from the receiver's loudspeaker. Usually there is a difference between receiver noise and an interference signal. If you are unsure, disconnect the input coaxial cable to see and hear the difference. Measuring near receiver noise floor should be avoided whenever possible, because the noise and interference to be measured add up to a higher reading. Whenever possible reduce input attenuation to shift the indicator near the 0 dB (centre of meter) position. This means best precision because of best compromise between noise and overload.

12.2.2 Scales

The upper scale is the logarithmic scale, the lower the linear scale.

Both of them have the 0 dB centre of meter.

On this point the receiver have optimum precision, which is derived from the internal pulse standard by substitution.

To the left precision is reduced because of receiver internal noise.

To the right precision is reduced because of potential overload (pulse compression especially with slow pulses/clicks).

12.2.2.1. Linear scale

Obviously the linear scale has no linear scaling (equal distances for dBs), which is somewhat of a contradiction.

The explanation for this strange behaviour is that the scale behaves linearly concerning voltages in V or μV , not $\text{dB}\mu\text{V}$.

The receiver converts the voltage on its input connector into proportional readings on the meter.

If we would make a scale in V or μV , this scale would be a linear scale.

However the scale used is a $\text{dB}\mu\text{V}$ -scale, according to a logarithmic law.

Because of this logarithmic law the distances increase from left to right.

The table below shows this for some characteristic values.

Input voltage is in μV and the attenuator setting is 0 dB.

Input voltage in μV	Meter reading on the linear scale
0,316 μV	-10
0,354 μV	-9
0,398 μV	-8
0,446 μV	-7
0,501 μV	-6
0,501 μV	-5
0,630 μV	-4
0,707 μV	-3
0,794 μV	-2
0,891 μV	-1
1,000 μV	0 dB Centre of Meter
1,122 μV	+1
1,259 μV	+2
1,413 μV	+3
1,584 μV	+4
1,778 μV	+5
2,000 μV	+6

For the difference of 1 dB from -10 dB to -9 dB only an input voltage difference of 0,122 μV is needed.

For the difference between +5 dB and +6 dB we need 0,686 μV , nearly 6 times more.

This corresponds to the distances in the dB-scaling.

12.2.2.2 Logarithmic Scale

This scale permits a wide overview in a dB-linear scaling.

This is done by an analogue lin/log-converter.

In its right part the logarithmic scale can indicate 20 dB higher voltages, in its left part 15 dB smaller voltages than the linear scale.

Fast overview is easier this way, because switching of the attenuator is avoided.

On the other hand there are some limitations and problems, which could cause errors.

A) Errors caused by receiver noise:

Measuring within the frequency range of band B (150 kHz-30 MHz) and low distortion, a noise level of approx. -14 dB is present on the logarithmic scale, which might be considered as an interference signal caused by the d. u. t..

It is a good practice to listen to the loudspeaker to decide, if its noise or interference. Disconnecting the input coaxial cable shows clearly if the signal is produced inside or outside the receiver.

B) Overloading the receiver:

Even though the receiver is protected against damage especially in the protected input mode, there is a danger of wrong measurement especially when slow pulses are measured.

The situation is even worse, when the frequency spectrum shows big difference between minimum and maximum, which is often the case with high power inverters.

Connected to a l.i.s.n. they may well deliver interference voltages up to some volts to the EMI-receiver in the frequency range up to about 100 kHz.

At higher frequency the amplitudes are rapidly decreasing by 50 dB to 80 dB.

Such spectrum completely „consumes“ the available dynamic range of the receiver.

There is no safety margin to use the logarithmic scale near is +20 dB point in the low noise mode.

Under these circumstances a superimposed slow pulse might be measured too low, because the receiver has no more „breath“ left for the pulse.

On the other hand, the high voltages in the in the low frequency band might cause intermodulation distortion which could result in measurements at higher frequencies which are wrong, because they are produced in the receiver itself.

These problems occur far beyond the limits of standard measurements especially with high power, slow pulse equipment.

Standard equipment such as PCs and microprocessors don't show these characteristics.

It is good practice to check measurement with the receiver on the safe side, which means low distortion on linear scale.

13 Function

13.1 Basics of development

It all began with manually operated interference measurement receivers with a conventional meter to read measurement. These receivers dominated the market for several decades. Due to their simplicity (few components) and the concentration on the important features these receivers were relatively small, light weight, reliable, cheap and easy to use. Many of these Schwarzbeck receivers are still in use and estimated very high by the users.

Recent electronic development however made front panel operation more convenient and introduced pc-control. Estimated very high by the users.

13.2 Basic function

The FCKL 1528 is a interference measurement receiver for 2 bands (frequency ranges). These are CISPR 3 (vlf) 9 kHz-150 kHz with 200 Hz 6-dB bandwidth and CISPR 1 (hf) 150 kHz-30 MHz with 9 kHz 6-dB-bandwidth (also described in VDE 0876 and CISPR publication 16).

The receiver's frequency can be tuned by an optical encoder on the front panel. The changes concerning the 2 band are automatically on 150 kHz. This concerns bandwidth, charge and discharge time of the quasi-peak detector, the calibration generator and the frequency steps. An info range permits an overview with band B standards down to 100 Hz. Using the automatic scanning procedure with a xy-recorder the receiver records a spectrum in one range from 9 kHz-30 MHz.

The frequency steps change automatically and the scan speed is adapted to the spectrum to come by variscan. So no additional adjustments are needed.

One single rotary switch determines manual tuning or scanning and provides for setting of the corner frequencies to adjust the xy recorder.

The desired input voltage range is determined by programmable step attenuator from 0 dB μ V to 105 dB μ V in 1 dB steps. In this way both high sensitivity (below 1 μ V) and overload protection against spikes coming from L.I.S.N.s are achieved. This input protection is made by a 10 dB power attenuator directly at the receiver's input. The 3 digit display (plus sign) includes the attenuation of the power attenuator, the i. f.-attenuation and the correction for the active magnetic antenna FMZB.

13.2.1 Receiver unit

The receiver unit of the FCKL 1528 begins at the input connector and ends at the active demodulator, The power attenuator, the step attenuator, the input filters, the active part and the frequency synthesiser generating all frequencies belong to this unit.

13.2.2 Calibration generator

This unit generates the reference signal for the calibration in all standards. The signal is generated for the 2 different standards band A and B.

13.2.3 Indication unit

It consists of the detectors, the measuring amplifiers, the automatic calibration and many other circuits.

13.2.4 Control logic

The control logic consists of the front panel board with all controls and displays and two back boards.

13.2.5 Power supply

The power supply provides for all voltages. + 12 V and - 12 V can be tapped on the rear side sub-d-connector for accessories.

13.2.6 IEEE interface

Converts the bus signals in control signals for the control logic. Part of this unit is a 12 bit a/d converter. It converts directly the meter voltage for PC and software.

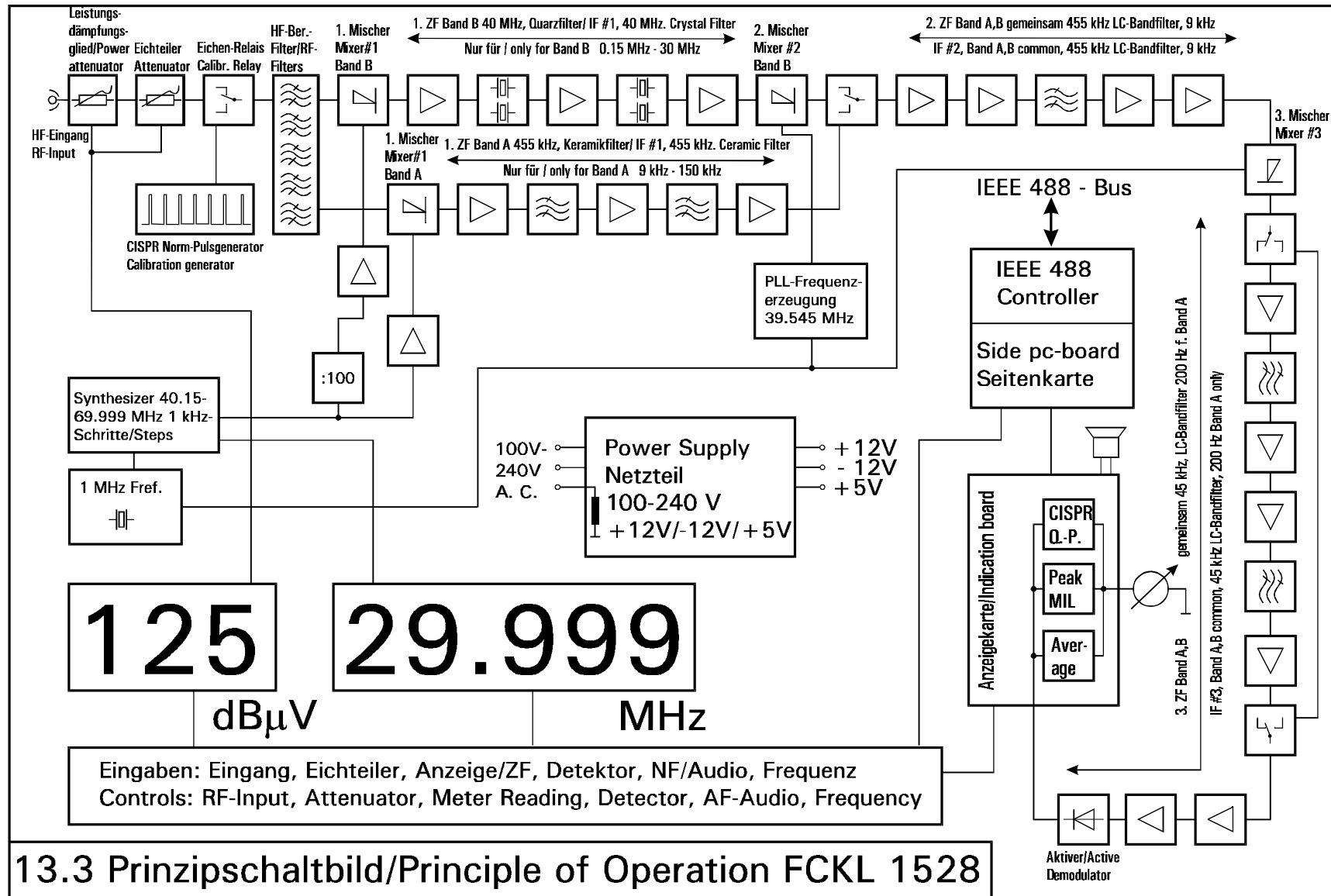

Diagram

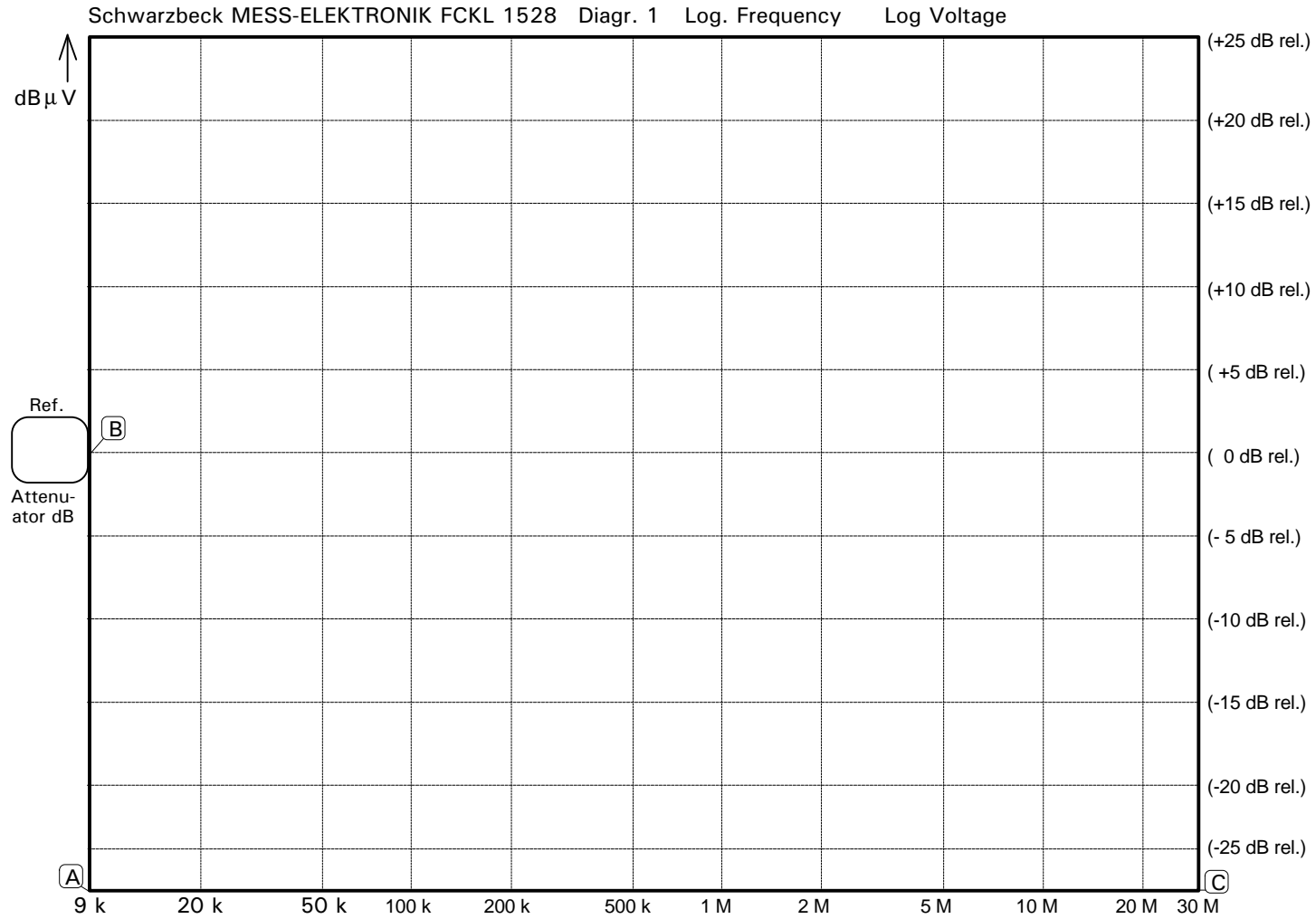

Diagram

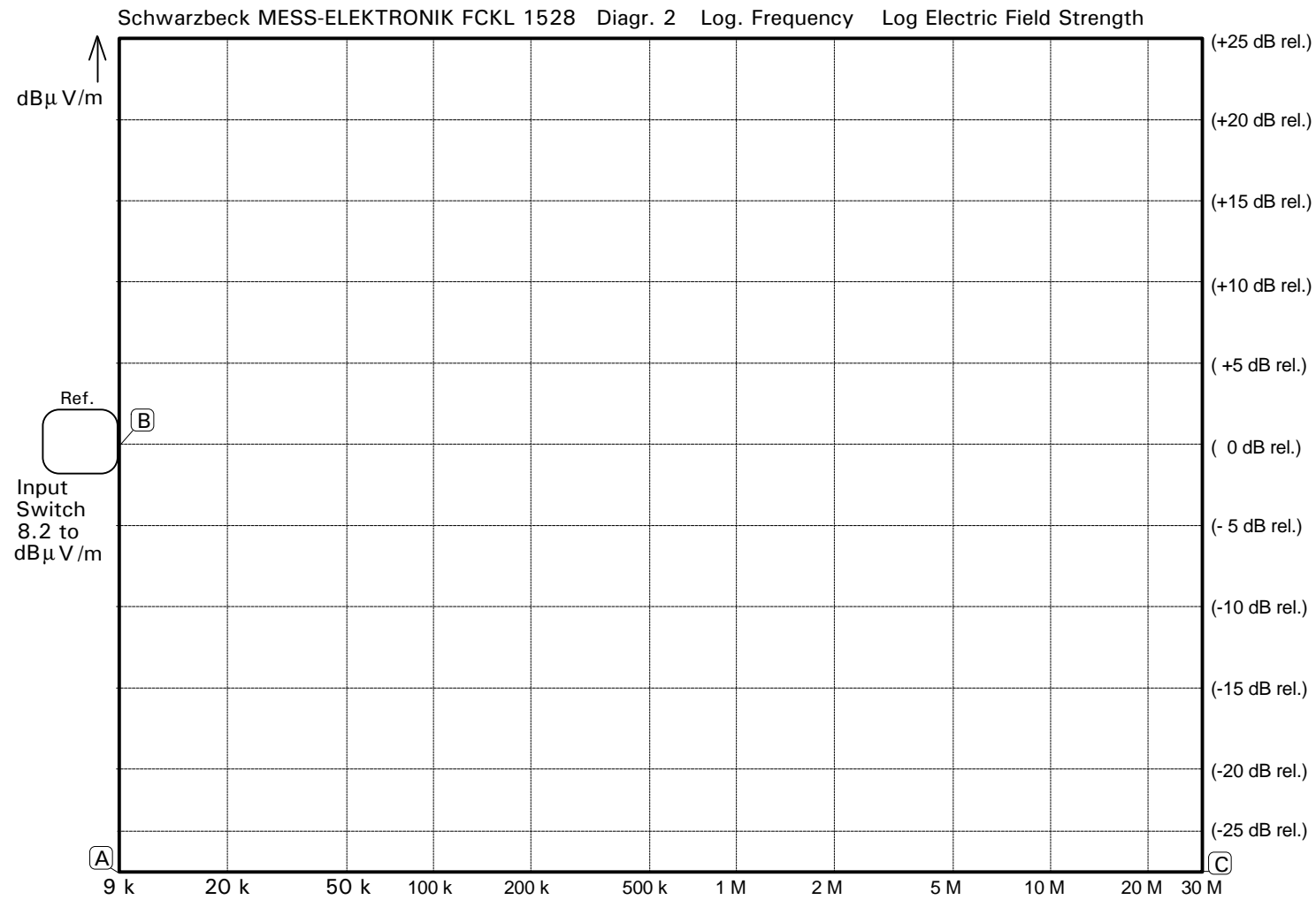

Diagram

